



SPEEDY F2

**Easy-running rigid frame wheelchair
with individual frame geometry made to measure
permanently welded chassis**

Maximum user weight limit 120 kg

A9015100000 € 5,370.00

Quotation date: _____

**Consultation was carried out by
Staff at the medical supplies shop:** _____

Order date: _____

according to GTC PRO ACTIV Reha-Technik GmbH

Medical suppliers / company address:

Cust. no.: _____
Name: _____
Street: _____
Postcode / city: _____
Phone: _____
Fax: _____
E-Mail: _____
Contact: _____

Shipping address: same as company address

Other (see below)

Name: _____
Street: _____
Postcode / city: _____

Customer name / commission:

Surname, forename: _____
Street: _____
Postcode / city: _____
Phone: _____
Fax: _____
E-Mail: _____
D.O.B: _____
Paying organisation: _____

Invoicing address: same as company address

other (see below)

Cust. no.: _____
Name: _____
Street: _____
Postcode / city: _____
Phone: _____
Fax: _____
E-Mail: _____
Contact: _____

**Note: We kindly would like to receive a picture of the
customer in the wheelchair (the face can be blurred).**

Body size:

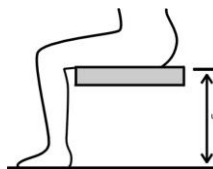

Body height: _____ cm

Weight: _____ cm

Lower leg length: _____ cm

(anatomic dimension: hollow of the knee to the foot sole)

Indication: _____

This information is necessary for checking. If the information
is missing, a check of the relevant items cannot be made!

Individual frame geometry oversized:
A9015120000

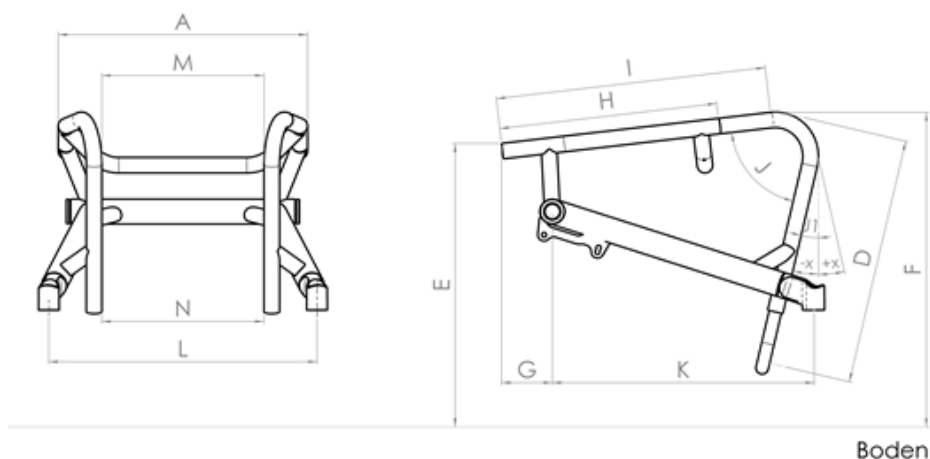

Standard equipment for the frame includes a base plate.

Equipment without base plate (explicitly requested) A9015100001

For "equipment without base plate", no adaptations (anti-tipping support, transit roller, wheelbase extension, etc.) can be retrofitted.

Wheelchair dimensions:

A: SB Seat width	_____ cm	H: Start frame retraction (I - min. 6 cm)	_____ cm
B: ST Seat depth	_____ cm	I: Frame length to the front frame bend (min. ST - 1 cm)	_____ cm
C: RH Back height	_____ cm	J: KW Knee angle	_____ °
D: USL Lower leg length	_____ cm	or	
E: SHh Seat height back	_____ cm	J1: Angle of the front Framework tube to vertical	_____ °
F: SHv Seat height front	_____ cm	K: Position of the steering wheel bearing block	_____ cm
G: KP Tipping point (front side rear tube to axis middle drive wheel)	_____ cm	L: Distance between steering wheel bearing blocks	_____ cm
		M: Lower leg width top	_____ cm
		N: Lower leg width button	_____ cm

Note: In the case of oversized frame geometry, the seat tube is manufactured as standard from a seat tube angle of approx. 30° to the horizontal with a tube bend.

Dimensional tolerances according to DIN EN ISO 13920 apply for the design (dimensions in mm)

Degree of accuracy	Up to 30	More then 30 to 120	More then 120 to 400	More then 400 to 1000
C	+/- 1	+/- 3	+/- 4	+/- 6

Frame colour - one-colour design

Information on current colour designs and example images at: www.proactiv-gmbh.de/farben.php

Frame colour: Selection from colour palette

Frame colour will be specified with order

A9000100170-000

Raw, blasted, not coated

A9000100170-020

Note: In combination with moisture e.g. hand perspiration, can affect dark aluminum discoloration.

Powder colours

White RAL 9016

gloss A9000100170-023

matt A9000100170-123

€ 42.10

Brilliant silver

gloss A9000100170-011

Anthracite RAL 7016

gloss A9000100170-001

matt A9000100170-101

€ 42.10

Black RAL 9005

gloss A9000100170-003

matt A9000100170-019

€ 42.10

Pure orange RAL 2004

gloss A9000100170-022

matt A9000100170-122

€ 42.10

Pink magenta RAL 4010

gloss A9000100170-037

matt A9000100170-137

€ 42.10

Pastel blue RAL 5024

gloss A9000100170-036

matt A9000100170-136

€ 42.10

Lemon green

gloss A9000100170-005

matt A9000100170-105

€ 42.10

Yellow RAL 1023

gloss A9000100170-046

matt A9000100170-146

€ 42.10

Red RAL 3001

gloss A9000100170-047

matt A9000100170-147

€ 42.10

Lagoon blue

gloss A9000100170-052

matt A9000100170-152

€ 42.10

Athletic grey

gloss A9000100170-050

matt A9000100170-150

€ 42.10

Muddy grey

gloss A9000100170-051

matt A9000100170-151

€ 42.10

Powder colours „Dormant“

Deep black effect silver

gloss A9000100170-007

Sky blue

gloss A9000100170-017

Navy blue

gloss A9000100170-045

matt A9000100170-145

€ 42.10

Electric green

gloss A9000100170-015

matt A9000100170-115

€ 42.10

Violet

gloss A9000100170-044

Fire red

gloss A9000100170-018

matt A9000100170-118

€ 42.10

Frame colour - One-colour design special colours “liquid coating”

€ 339.40

Storm (ice blue)

gloss A9000100170-500

matt A9000100170-501

Coffee

gloss A9000100170-520

matt A9000100170-521

Prairie (rose gold)

gloss A9000100170-504

matt A9000100170-505

Pearl (mother of pearl-white)

gloss A9000100170-524

matt A9000100170-525

Berry

gloss A9000100170-526

matt A9000100170-527

Blue ocean

gloss A9000100170-522

matt A9000100170-523

Emerald

gloss A9000100170-514

matt A9000100170-515

Mint

gloss A9000100170-528

matt A9000100170-529

Chili

gloss A9000100170-516

matt A9000100170-517

Frame colour - Two-colour design

Note: In the two-colour design, both colours are the same gloss level as the design colour.

Two-colour design with one base colour (on the rear frame) and one design colour (on the front frame) € 260.70

Please select a color from below:

Base colour (on the rear frame)

White RAL 9016

A9000100170-200

Brilliant silver

A9000100170-201

Anthracite RAL 7016

A9000100170-202

Black RAL 9005

A9000100170-203

Pastel blue RAL 5024

A9000100170-206

Lemon green

A9000100170-207

Yellow RAL 1023

A9000100170-208

Lagoon blue

A9000100170-212

Athletic grey

A9000100170-210

Muddy grey

A9000100170-211

Design colour (on the front frame)

Black RAL 9005

gloss A9000100170-259

matt A9000100170-260

Lemon green

gloss A9000100170-250

matt A9000100170-251

Chili

gloss A9000100170-253

matt A9000100170-254

Pure orange RAL 2004

gloss A9000100170-255

matt A9000100170-256

Coffee

gloss A9000100170-278

matt A9000100170-279

Mint

gloss A9000100170-286

matt A9000100170-287

Emerald

gloss A9000100170-274

matt A9000100170-275

Storm (ice blue)

gloss A9000100170-264

matt A9000100170-265

Prairie (rose gold)

gloss A9000100170-266

matt A9000100170-267

Pearl (mother of pearl-white)

gloss A9000100170-282

matt A9000100170-283

Berry

gloss A9000100170-284

matt A9000100170-285

Blue ocean

gloss A9000100170-280

matt A9000100170-281

Colour - Attachment parts

Note: If not specified, the caster fork and bearing block will be mounted in black.

Drive wheel: aluminum rim, hub and spokes

Black A9000100171-003

Caster fork and bearing block

Silver A9000100173-011

Black A9000100173-003

Colour design of attachment parts according to customer request:

Drive wheel: Aluminium rim and design inlet¹

Frame colour A9000100171-999 € 242.30

Select from one-colour design (different from the frame color) A9000100171-998 € 280.50

Colour: _____

A9000100170-

Caster wheel: 5" aluminium rim² (3-spoke design)

Frame colour A9000100174-999 € 73.00

Select from one-colour design (different from the frame color) A9000100174-998 € 84.60

Colour: _____

A9000100170-

Special colour requests (frame or attachment parts)

Frame colour for single purchasing

Selection from RAL colour palette

A9000100170-100 € 402.30

Gloss level

gloss

matt

colour name

RAL number

Note: attachment parts are **not** possible in design colors

¹ Only in conjunction with Liteline hub (with drive wheel aluminum rim with 18 or 36 spokes, single rim)

² Only in conjunction with caster wheel 5" aluminum rim 3-spoke design good shock absorption A900050121*, as well as with suspension fork 5-spoke design A9000500160*

Push handles

Back tube with integrated handles

A9000401051-K € 126.60
straight



Aluminum push handles fixed in back tube

A9000401050 € 126.60
from RH 23 cm



Horizontal push handles screwed into the back tube

A9000401076 € 234.80
can be unscrewed



Safety push handles height adjustable

A9000401060* € 210.10

Mount in the back tube from RH 30 cm with adaptable back from RH 35 cm for back tube with lordosis support from RH 43 cm with back shell



Safety push handles back-positioned length 45 cm

A9000401075 € 362.00

continuous height adjustment, Safety push handle holder mounted on the back cross bar Up to SB 42 cm or body weight 95 kg Not in combination with swing-away armrest



Equipment without push handles

A9000401000

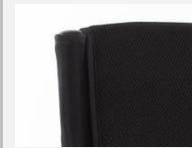

Backrest

Aluminum side guard, contour following the wheel

A9015402470-002
Backrest screwed, not foldable, back angle 90° to the floor Adapted to the upper edge of the tyre



Aluminum side guard, contour by indicated dimension

A9015402470-001 € 162.80

Bolted backrest, cannot be folded Indicated dimension:

A = __ cm / B = __ cm

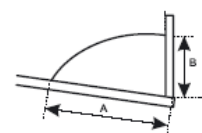

Aluminum side guard, with bolted clothing guard

A9015400025 € 350.70

Bolted backrest, cannot be folded Wheel cover runs parallel to the contour to the drive wheel tyres at a Distance of approx. 8 to 12 mm



Aluminum side guard, with integrated clothing guard

A9015400026 € 637.70

Clothing guard and side panel in one piece, individually manufactured, coated in frame colour. Permanently bolted backrest, cannot be folded, Wheel cover runs parallel to the contour to the drive wheel tyres at a Distance of approx. 8 to 12 mm



Carbon side panel, with integrated clothing guard

A9015400028 € 877.90

Clothing guard and side panel in one piece, individually manufactured. Permanently bolted backrest, cannot be folded, backrest angle 90° to the floor, wheel cover runs contour-parallel to the drive wheel tyres at a distance of approx. 8 - 12 mm



Folding backrest

A9000400011
7-way angle adjustable,
with integrated plastic-coated aluminum side
parts



Back tube with lordosis support

- A9000400005-K € 111.10
- 1 cm
 2 cm
 3 cm



Back equipment

If not specified, the "Adaptable back with back padding" will be delivered.

Adaptable back with back padding

A9000802010-K
Cover: Black, breathable, open surface
Equipment with back cross bar



Equipment without back upholstery and back padding or back system

A9000802011 € - 53.00
Equipment with back cross bar

For other back systems for example ergonomic back shell, see
separate order sheet: "PRO ACTIV seat and back systems"



Seat upholstery

If not specified, the "Body Contour seat upholstery" will be delivered.

Body Contour

A9000801025-K
approved up to a body weight of 120 kg

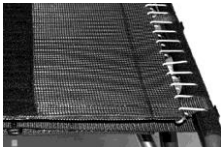

Open belt system

A9000801010-K € 74.70

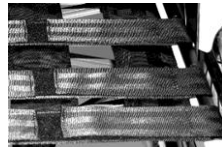

Equipment without seat upholstery

A9000801050



Sitzkissen

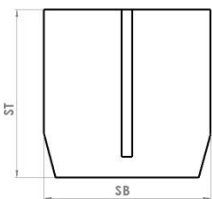

Seat cushion for individual frame
geometry in rectangular contour
Inlet: Standard

A9000805190-K € 156.70

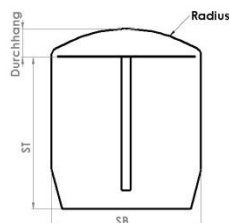

Seat cushion for individual frame
geometry with radius contour
Inlet: Standard

A9000805320-K € 200.10

Seat cushion height:

- 3 cm 5 cm
 4 cm 6 cm

Seat cushion for individual frame geometry in rectangular contour Inlet: Anti-Decubitus <input type="checkbox"/> A9000805210-K € 467.40	Seat cushion for individual frame geometry with radius contour Inlet: Anti-Decubitus <input type="checkbox"/> A9000805310-K € 510.40	Seat cushion height: <input type="checkbox"/> 4 cm <input type="checkbox"/> 6 cm
--	---	---

Cover:

- Black, breathable, open surface
- Black, breathable, closed surface

If no specification is made, the cover material "Black, breathable, open surface" will be delivered.

Seat cushion is existing

You can also find the seat cushions on our separate order sheet: "PRO ACTIV seat and backrest systems"

Clothing guard

Aluminum clothing guard removable via lock function

Adjustable following wheel arch
 Only in combination with folding backrest



in anthracite matt

A9000403215-K € 236.10

in frame colour (basic colour with two-colour design)

A9000403216-K € 302.00

in design colour (only possible with frame colour in two-colour design)

A9000403217-K € 335.00

Carbon clothing guard removable via lock function

A9000400013-K € 547.30

Adjustable following wheel arch
 Only in combination with folding backrest



Wheelbase extension

Wheelbase extension, angle-adjustable and removable

A9015100005 € 711.20

with continuous axle tube,
 height adjustment via gear joint
 adjustable in 6° angular increments
 wheel position displacement approx. 14 cm
 4°/6° camber integrated, adjustable track
 Attachment possibility must be checked by PRO ACTIV.
 Only in combination with base plate.
 Up to 120 kg load capacity.



Wheelbase extension permanently welded

A9015100002 € 613.20

with second axle tube, 1°/ 4° or 6° camber integrated,
 distance between axle tubes 150 mm as standard, other distances according to drawing set
 Track can be adjusted independently
 Version must be checked by PRO ACTIV
 Only possible without base plate

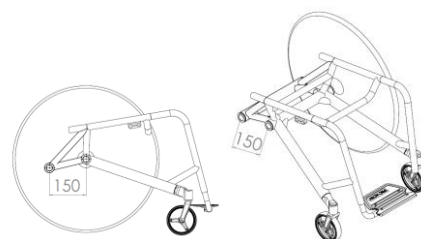

Wheel camber

*Total width with tight-mounted handrim.

1° drive wheel camber

A9016202010
 Total width = approx. SB + 20 cm*

2,5° drive wheel camber

A9016202051

4° drive wheel camber

A9016202030
 Total width = approx. SB + 26 cm*

6° Antriebsradsturz

A9016202040
Total width = approx. SB + 30 cm*

Brake system

If not specified, the "Brake system push to lock with standard brake handle" will be delivered.

Recommendation: For KP 7 cm or lower, we recommend the „Brake system push to lock with brake handle 20° outwards“.

Integral parking brake positioned on lower frame tube

A9015705001 € 520.90



Integral parking brake positioned on upper frame tube

A9015705000-K € 514.40

Please note:

In order to maintain the function of the foldable backrest, the plastic-coated side part version is mounted "-5", guided low by the contour, thus preventing collision with the integral brake when the backrest is folded down.



Brake system push to lock Standard brake handle

A9000701010-001



Brake system push to lock Long brake handle

A9000701010-002



Brake system push to lock Low brake handle

A9000701010-003



Brake system push to lock Brake handle 20° outwards

Standard brake handle
A9000700002

Long brake handle
A9000701010-004

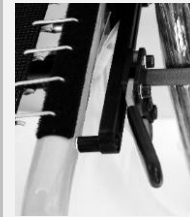

Brake system push to lock Brake handle to flip-down

A9000706008 € 154.00

Length: 9 cm



Brake system push to lock with cable pull operation

A9000700001 € 335.70

Brake mounted on the bottom frame tube.
Operation via Bowden cable, operating handle mounted on the seat tube in the area of the frame bend

Attachment possibility must be checked by PRO ACTIV individually



Footrest

If not specified, the "continuous footrest" will be delivered.

Continuous footrest

A9016601010-K*
with tubular resting bracket
height adjustable +/- 3 cm
If the footrest is wanted with a "rubber coated
footplate", please select this under "Footrest
accessories"



Footrest folds up to the rear with spring locking mechanism

A9016602005-K* € 279.00
with tubular resting bracket
from USL 40 cm
only with V-shape and long frame
If the footrest is wanted with a "rubber coated
footplate", please select this under "Footrest
accessories"



Footrest folds up to the rear

A9016602010-K* € 298.90
with tubular resting bracket and 20 mm
operating lever
If the footrest is wanted with a "rubber coated
footplate", please select this under "Footrest
accessories"



Footrest accessories

Rubber coated footplate

A9000610000-K € 122.20
bolted, angle-adjustable
Depth: 14 cm



Footrest side stop

A9000610100 € 58.00
adjustable
only in combination with rubber coated
footplate



Adaptations

Anti-tipping support

right side € 182.40
A9000300100-K003
 left side € 182.40
A9000300100-K004
pivotable, screwed to the welded base plate
with tension spring
Not in combination with other removable
wheelbase extension.



Transit wheels

A9000301100 € 320.00
with universal adapter, removable
not in combination with anti-tipping support



Tilting clamp

right side € 136.00
A9000302101-001
 left side € 136.00
A9000302101-002
with universal adapter and Quick pin
not in combination with anti-tipping support,
right side or left side

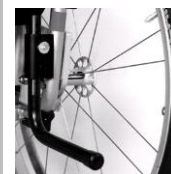

4 Dance central anti-tipping support

A9000300010 € 502.30
removable via quick release lever with rotating
caster fork and skate wheel Ø 80 mm
adjustable ground clearance and angle
Colour: black



3" caster wheel

3" safety light-up wheel (80 mm)

A9000501110 € 68.70
puncture-proof



4" caster wheel

4" caster wheel „Standard“ solid rubber black

A9000501011-004
(82A), puncture-proof



4" Skate wheel (100 mm)

A9000501120 € 68.70
puncture-proof



4" safety light-up wheel (100 mm)

A9000501220 € 92.00
puncture-proof



4" Frog Legs caster wheel (100 mm)

A9000501230 € 206.30
with replaceable rubber 6 mm, puncture-proof
Colour: black, silver rim
Incl. hair guard spacer (5.3 mm)



5" caster wheel

5" caster wheel „Standard“ PU black

A9000501036-005
(82A), puncture-proof



5" caster wheel „Standard“ PU grey

A9000501031-005
(82A), puncture-proof



5" safety light-up wheel (125 mm)

A9000501221 € 92.00
puncture-proof



5" aluminum rim 3-spoke design “good shock absorption”

Silver
A9000501210 € 174.60

Black
A9000501211 € 174.60

with replaceable rubber 6 mm medium hard,
puncture-proof
Incl. hair guard spacer (3 mm)



5" Frog Legs caster wheel (125 mm)

A9000501232 € 206.30
with replaceable rubber 6 mm, puncture-proof
Colour: black, silver rim
Incl. hair guard spacer (5.3 mm)



6" caster wheel

6" caster wheel „Standard“ PU grey

A9000501010-006
(82A), puncture-proof



6" caster wheel "pneumatic tyre"

A9000501050 € 55.50



6" caster wheel "Flexel System"

A9000501070 € 55.50
puncture-proof



Caster fork

If not specified, the "standard caster fork with screw axle" is supplied.

Caster fork Standard

A9000500100-K001
with screwed axle

A9000500100-K002 € 162.50
with quick-release axle



Caster fork short

A9000500110-K001
with screwed axle
Not in combination with 6" steering wheels

A9000500110-K002 € 162.50
with quick-release axle
Not in combination with 5" or 6" caster wheels



Caster fork Heavy Duty for high loads

Extra weight approx. 100 - 150 gr.

A9000510111-K001 € 52.40
with screwed axle

A9000510111-K002 € 212.50
with quick-release axle



Caster fork Heavy Duty short for high loads

A9000510120-K001 € 52.40
with screwed axle
Not in combination with 6" steering wheels

A9000510120-K002 € 212.50
with quick-release axle
Not in combination with 5" or 6" caster wheels

Suspension fork

inkl. 5" aluminum rim "good shock absorption"

A9000500160-K002 € 598.90
with quick-release axle



Caster fork spare wheel „Standard“

A9000500300-K € 288.10
Caster fork Standard with quick-release axles



Caster fork spare wheel „Heavy Duty“

A9000500301-K € 328.10
Caster fork Heavy Duty with quick-release axles



The spare caster fork does not have a caster wheel.
In case a caster wheel is requested, please put a cross on a second selection in the category "Caster wheels".

Drive wheels

Information about other rim types, designs and availability can be found at: www.proactiv-gmbh.de.
If not specified, the "drive wheel 36 spokes aluminum rim" will be delivered.

Drive wheel 18-spoke aluminum rim

- 24" (ETRTO 540)
A9000203122

with Liteline hub, radially spoked

Not in combination with:

- Puncture-proof tyres
- One-hand drive
- Drum brake
- Handbike

up to 70 kg body weight:

Sturz \ Gewicht	1°	4°	6°	8°	10°
bis 50 Kg	✓	✓	✓	✓	✓
51 - 60 Kg	✓	✓	✓	✓	
61 - 70 Kg	✓	✓			



Drive wheel 36-spoke aluminum rim

- 24" (ETRTO 540)
A9000203000-010

with Liteline hub (left image),
radially spoked

up to 120 kg body weight

- 24" (ETRTO 540)
A9000203000-020

with aluminum front hub (right image),
radially spoked
over 120 kg body weight



Drive wheel double rim 36-spokes

- 24" (ETRTO 540)
A9000203100 € 153.20

- 25" (ETRTO 559)
A9000203200 € 153.20

- 26" (ETRTO 590)
A9000203300 € 153.20

with aluminum front hub,
radially spoked
Use with higher loads and body weight
> 120 kg



Spinergy wheel "Spox Sport" with 24 PBO spokes; rim, hub and spokes in black

- 24" (ETRTO 540)
A9000203550 € 761.30

- 25" (ETRTO 559)
A9000201559 € 761.30

- 26" (ETRTO 590)
A9000203555 € 761.30



Spinergy „Everyday Light Extreme“ with 12 PBO spokes; rim and hub in black, spokes in white

- 24" (ETRTO 540)
A9000203554 € 929.30

Recommendation: up to 70 kg body weight,
not in combination with handbike/traction
device use.



Spinergy „Everyday Light Extreme“ with 12 PBO spokes; rim, hub and spokes in black

- 24" (ETRTO 540)
A9000203552 € 929.30

Recommendation: up to 70 kg body weight,
not in combination with handbike/traction
device use.



Handrims

x = dimension handrim attachment

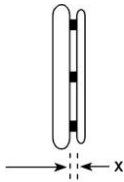

Handrim attachment general:

- x = 11 mm
- x = 19 mm

Handrim attachment Curve + Gekko handrim:

- x = 10 mm
- x = 18 mm

If not specified, the handrim will be mounted wide (19 mm / 18 mm).

Stainless steel Ø 20 mm

- 24" handrim for 24" wheel and 25" wheel A9000205010-004
- 26" handrim for 26" wheel A9000205010-006



Aluminum Ø 19 mm silver anodised

- 24" handrim for 24" wheel and 25" wheel A9000205019-004



Aluminum Ø 19 mm powder coated in frame colour

(basic colour with two-colour design)

- = Gloss surface
- = Matt surface

Note: Matt coating is not recommended due to the low grip.

- 24" handrim for 24" wheel and 25" wheel **€ 66.30** A9000205020-004
- 26" handrim for 26" wheel **€ 66.30** A9000205020-006



Aluminum Ø 19 mm polished and hard-anodised

- 24" handrim for 24" wheel and 25" wheel **€ 160.10** A9000205030-004
- 26" handrim for 26" wheel **€ 160.10** A9000205030-006



Titanium Ø 19 mm

- 24" handrim for 24" wheel and 25" wheel **€ 325.80** A9000205040-004
- 26" handrim for 26" wheel **€ 325.80** A9000205040-006



Silicone handrim cover

- for 24" handrim **€ 226.00** A9000205100-004
- for 26" handrim **€ 226.00** A9000205100-006

Surface without structure, compatible with handrim Ø 19 mm or Ø 20 mm.



Ultra-Grip „very grippy“

- 24" handrim for 24" wheel and 25" wheel **€ 390.70** A9000205070-004
- 26" handrim for 26" wheel **€ 390.70** A9000205070-006



Ergo-Grip

- 24" handrim for 24" wheel and 25" wheel **€ 396.80** A9000205080-004
 - 26" handrim for 26" wheel **€ 396.80** A9000205080-006
- Attachment fitting to the rim



Curve black anodised, ergonomic handrim profile

- 24" handrim for 24" wheel and 25" wheel **€ 389.10** H 24 mm A9000205130-004
- 24" handrim for 24" wheel and 25" wheel **€ 389.10** H 31 mm, size L A9000205140-004
- 26" handrim for 26" wheel **€ 389.10** H 31 mm, size L A9000205140-006



<p>Curve silver anodised ergonomic handrim profile</p> <p><input type="checkbox"/> 24" handrim for 24" wheel and 25" wheel H 31 mm, size L A9000205160-004 € 394.30</p> 	<p>Curve powder-coated, ergonomic handrim profile</p> <p><input type="checkbox"/> = Frame colour (gloss surface) <input type="checkbox"/> = Black (gloss surface)</p> <p><input type="checkbox"/> 24" handrim for 24" wheel and 25" wheel H 24 mm A9000205135-004 € 454.00</p> <p><input type="checkbox"/> 24" handrim for 24" wheel and 25" wheel H 31 mm, size L A9000205145-004 € 454.00</p> <p><input type="checkbox"/> 26" handrim for 26" wheel H 31 mm, size L A9000205145-006 € 454.00</p> 	<p>Curve Grip, with Tetra-Grip coating, ergonomic handrim profile</p> <p><input type="checkbox"/> 24" handrim for 24" wheel and 25" wheel H 31 mm, size L A9000205150-004 € 505.50</p> 
<p>Quadro with Tetra-Grip coating</p> <p><input type="checkbox"/> 24" handrim for 24" wheel and 25" wheel A9000205170-004 € 517.50</p> <p><input type="checkbox"/> 25" handrim for 25" wheel A9000205170-005 € 517.50</p> <p><input type="checkbox"/> 26" handrim for 26" wheel A9000205170-006 € 517.50</p> 	<p>Gekko black anodised</p> <p><input type="checkbox"/> 24" handrim for 24" wheel and 25" wheel A9000205175-004 € 501.20</p> <p><input type="checkbox"/> 25" handrim for 25" wheel A9000205175-005 € 501.20</p> <p><input type="checkbox"/> 26" handrim for 26" wheel A9000205175-006 € 501.20 with a robust and replaceable silicone lip, fully integrated into the profile</p> 	<p>Gekko silver anodised</p> <p><input type="checkbox"/> 24" handrim for 24" wheel and 25" wheel A9000205185-004 € 513.20 with a robust and replaceable silicone lip, fully integrated into the profile</p> 
<p>Gekko S black anodised</p> <p><input type="checkbox"/> 24" handrim for 24" wheel and 25" wheel A9000205195-004 € 501.20 with a robust and replaceable silicone lip, fully integrated into the profile Profile height 24 mm</p> 	<p>Equipment without handrims</p> <p><input checked="" type="checkbox"/> A9000205990</p>	

Spoke guard

Finger- and spoke guard "transparent"

for 24" wheel
A9000206300-004 € 201.10

for 26" wheel
A9000206300-006 € 201.10

Not in combination with Spinergy drive wheels.



Tyres

If not specified, the "Schwalbe RightRun in black" tyres will be delivered.

Schwalbe „RightRun“ High-pressure tyres

24x1" (540-25)
A9000204001-004

Colour: Black
7.5 bar

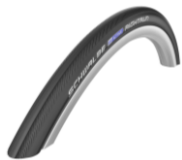

Schwalbe „RightRun“ High-pressure tyres

24x1" (540-25)
A9000204000-004

25x1" (559-25)
A9000204000-005

26x1" (590-25)
A9000204000-006

Colour: Grey, black wall
7.5 bar



Schwalbe „DownTown“ Profiled tyres

24x1" (540-25)
A9000204010-004

7.5 bar



Schwalbe „Marathon Plus Evolution“ with "smart guard" puncture protection

24x1" (540-25)
A9000204030-014 € 47.80

25x1" (559-25)
A9000204030-015 € 47.80

26x1" (590-25)
A9000204030-016 € 47.80

Colour: Black
10 bar



Schwalbe „Marathon Plus“ with "smart guard" puncture protection

24x1" (540-25)
A9000204030-004 € 47.80

Colour: Grey, black wall
10 bar



Schwalbe „One“

24x1" (540-25)
A9000204123-004 € 90.30

Colour: Black
9 bar



Puncture-proof "solid rubber tyres"

24x1" (540-25)
A9000204201-004 € 119.10

Colour: Black

Not in combination with 18-spoke drive wheel,
Spinergy and one-hand drive



Accessories

24" MTB spare wheel set

with double rim (ETRTO 507), aluminum front hub, quick-release axle and stainless steel handrim
Mountain bike tyres, selectively:

A9000203410 € 682.90

24x1.75" Schwalbe "Marathon Plus"
Brake setting compatible with 24x1" wheel



A9000203413 € 682.90

24x2.1" Schwalbe "SMART SAM Sport"
Brake setting not compatible with 24x1" wheel



Through axle with assistance, Large push button

A9000200096 € 102.70

Interlock dimension: 122 / 110 mm
Axle diameter: 12 mm
Not in conjunction with lockable drive wheel
axle clip "Tetra Clip",
not in combination with one-hand drive



Lockable drive wheel axle clip "Tetra Clip"

A9000206400 € 161.60

Not in combination with Spinergy drive wheels,
one-hand drive, drum brake or Liteline hub



Hand air compressor with pressure gauge

A9000901100 € 103.20

up to 14 bar



Length-adjustable safety belt with buckle

A9000902100 € 78.30



Adjustable safety belt with hook and fastener

A9000902110 € 62.60



Crutch holder with flexible nylon cup

A9000902310* € 133.40



SIGMA lighting set

A9000903270 € 104.80

Consisting of front light and rear lights,
chargeable via Micro USB socket,
incl. Micro USB charging cable
Lighting set compliant with road traffic
regulations



Transport bag for drive wheels

for 24" wheel
A9000903530-004 € 75.50

Ø 76 cm x 2 cm

for 26" wheel
A9000903530-006 € 75.50

Ø 83 cm x 2 cm



Further accessories (such as handbikes, steering attachments, etc.) see separate order form or www.proactiv-gmbh.de.

Notes and remarks:

Location, Date

Signature End customer/dealer

The signature field is intended for the consultant and insured person. This confirms that the intended equipment is intended for the insured person.

- 17 - 2024-06-01 / The prices are plus statutory value-added tax and shipping costs = Included in the basic price = Position selected
Order sheet SPEEDY F2 Rev. 06 UK