



SPEEDY F1

**Rigid frame sports wheelchair
 with individual frame geometry and custom
 equipment,**

Permanently welded chassis

Maximum user weight limit 120 kg

A9011100000 € 5,240.00

Invoicing address: same as company address

other (see below)

Cust. no.: _____
 Name: _____
 Street: _____
 Postcode / city: _____
 Phone: _____
 Fax: _____
 E-Mail: _____
 Contact: _____

Quotation date: _____
 Consultation was carried out by
 Staff at the medical supplies shop: _____

Order date: _____
 according to GTC PRO ACTIV Reha-Technik GmbH

Medical suppliers / company address:

Cust. no.: _____
 Name: _____
 Street: _____
 Postcode / city: _____
 Phone: _____
 Fax: _____
 E-Mail: _____
 Contact: _____

Shipping address: same as company address

Other (see below)

Name: _____
 Street: _____
 Postcode / city: _____

Customer name / commission:

Surname, forename: _____
 Street: _____
 Postcode / city: _____
 Phone: _____
 Fax: _____
 E-Mail: _____
 D.O.B: _____
 Paying organisation: _____

SPEEDY F1 basket



SPEEDY F1 tennis



SPEEDY F1 badminton



SPEEDY F1 4dance



Basic size

Body size:

Body height: _____ cm

Weight: _____ cm

Lower leg length: _____ cm

(anatomic dimension: hollow of the knee to the foot sole)

Indication: _____

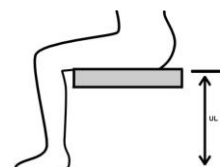

This information is necessary for checking. If the information is missing, a check of the relevant items cannot be made!

Wheelchair dimensions:

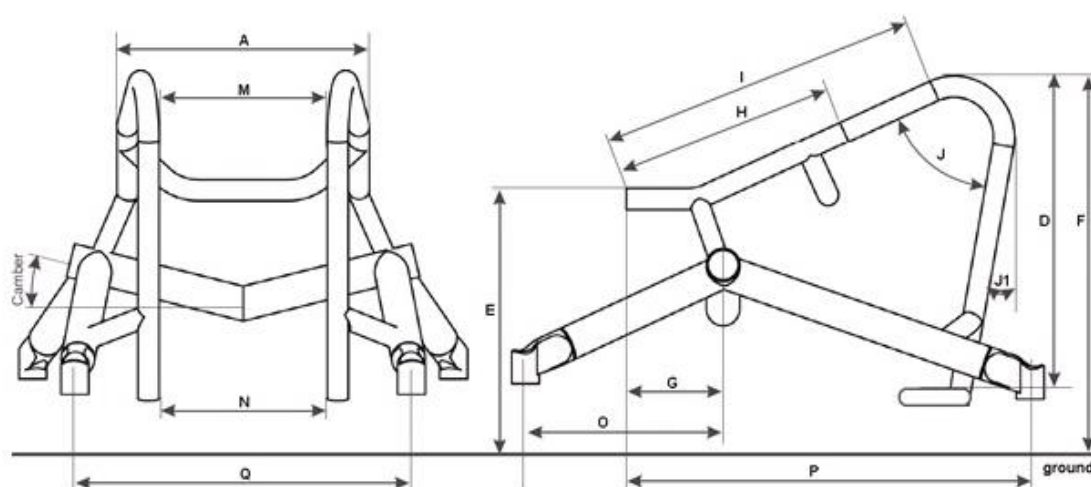

- | | |
|--|---|
| <p>A: SB Seat width _____ cm</p> <p>B: ST Seat depth _____ cm</p> <p>C: RH Back height _____ cm</p> <p>D: USL Lower leg length _____ cm</p> <p>E: SHh Seat height back _____ cm</p> <p>F: SHv Seat height front _____ cm</p> <p>G: KP Tipping point _____ cm
(front side rear tube to axis middle drive wheel)</p> <p>H: Start frame retraction _____ cm
(I - min. 6 cm)</p> | <p>I: Frame length to the front frame bend _____ cm</p> <p>J: KW Knee angle _____ °</p> <p>or</p> <p>J1: Angle of the front Framework tube to vertical _____ °</p> <p>M: Lower leg width top _____ cm</p> <p>N: Lower leg width button _____ cm</p> <p>O: Position of the tip support bearing block (in basketball, according to the rules, the drive wheel forms the rearmost point) _____ cm</p> <p>P: Position of the steering wheel bearing block (inner edge backrest to middle bearing block) _____ cm</p> <p>Q: Distance between steering wheel bearing blocks _____ cm</p> |
|--|---|

Dimensional tolerances according to DIN EN ISO 13920 apply for the design (dimensions in mm)

Degree of accuracy	Up to 30	More then 30 to 120	More then 120 to 400	More then 400 to 1000
C	+/- 1	+/- 3	+/- 4	+/- 6

Frame colour - one-colour design

Information on current colour designs and example images at: www.proactiv-gmbh.de/farben.php

Frame colour: Selection from colour palette

Frame colour will be specified with order

A9000100170-000

Raw, blasted, not coated

A9000100170-020

Note: In combination with moisture e.g. hand perspiration, can affect dark aluminum discoloration.

Powder colours

White RAL 9016

gloss A9000100170-023

matt A9000100170-123 € 42.10

Brilliant silver

gloss A9000100170-011

Anthracite RAL 7016

gloss A9000100170-001

matt A9000100170-101 € 42.10

Black RAL 9005

gloss A9000100170-003

matt A9000100170-019 € 42.10

Pure orange RAL 2004

gloss A9000100170-022

matt A9000100170-122 € 42.10

Pink magenta RAL 4010

gloss A9000100170-037

matt A9000100170-137 € 42.10

Pastel blue RAL 5024

gloss A9000100170-036

matt A9000100170-136 € 42.10

Lemon green

gloss A9000100170-005

matt A9000100170-105 € 42.10

Yellow RAL 1023

gloss A9000100170-046

matt A9000100170-146 € 42.10

Red RAL 3001

gloss A9000100170-047

matt A9000100170-147 € 42.10

Lagoon blue

gloss A9000100170-052

matt A9000100170-152 € 42.10

Athletic grey

gloss A9000100170-050

matt A9000100170-150 € 42.10

Muddy grey

gloss A9000100170-051

matt A9000100170-151 € 42.10

Powder colours „Dormant“

Deep black effect silver

gloss A9000100170-007

Sky blue

gloss A9000100170-017

Navy blue

gloss A9000100170-045

matt A9000100170-145 € 42.10

Electric green

gloss A9000100170-015

matt A9000100170-115 € 42.10

Violet

gloss A9000100170-044

Fire red

gloss A9000100170-018

matt A9000100170-118 € 42.10

Frame colour - One-colour design special colours “liquid coating”

€ 339.40

Storm (ice blue)

gloss A9000100170-500

matt A9000100170-501

Coffee

gloss A9000100170-520

matt A9000100170-521

Prairie (rose gold)

gloss A9000100170-504

matt A9000100170-505

Pearl (mother of pearl-white)

gloss A9000100170-524

matt A9000100170-525

Berry

gloss A9000100170-526

matt A9000100170-527

Blue ocean

gloss A9000100170-522

matt A9000100170-523

Emerald

gloss A9000100170-514

matt A9000100170-515

Mint

gloss A9000100170-528

matt A9000100170-529

Chili

gloss A9000100170-516

matt A9000100170-517

Frame colour - Two-colour design

Note: In the two-colour design, both colours are the same gloss level as the design colour.

Two-colour design with one base colour (on the rear frame) and one design colour (on the front frame) € 260.70

Please select a color from below:

Base colour (on the rear frame)

White RAL 9016

A9000100170-200

Brilliant silver

A9000100170-201

Anthracite RAL 7016

A9000100170-202

Black RAL 9005

A9000100170-203

Pastel blue RAL 5024

A9000100170-206

Lemon green

A9000100170-207

Yellow RAL 1023

A9000100170-208

Lagoon blue

A9000100170-212

Athletic grey

A9000100170-210

Muddy grey

A9000100170-211

Design colour (on the front frame)

Black RAL 9005

gloss A9000100170-259

matt A9000100170-260

Lemon green

gloss A9000100170-250

matt A9000100170-251

Chili

gloss A9000100170-253

matt A9000100170-254

Pure orange RAL 2004

gloss A9000100170-255

matt A9000100170-256

Coffee

gloss A9000100170-278

matt A9000100170-279

Mint

gloss A9000100170-286

matt A9000100170-287

Emerald

gloss A9000100170-274

matt A9000100170-275

Storm (ice blue)

gloss A9000100170-264

matt A9000100170-265

Prairie (rose gold)

gloss A9000100170-266

matt A9000100170-267

Pearl (mother of pearl-white)

gloss A9000100170-282

matt A9000100170-283

Berry

gloss A9000100170-284

matt A9000100170-285

Blue ocean

gloss A9000100170-280

matt A9000100170-281

Colour - Attachment parts

Note: If not specified, the caster fork and bearing block will be mounted in black.

Drive wheel: aluminum rim, hub and spokes

Black A9000100171-003

Caster fork and bearing block

Silver A9000100173-011

Black A9000100173-003

Colour design of attachment parts according to customer request:

Drive wheel: Aluminium rim and design inlet¹

Frame colour A9000100171-999 € 242.30

Select from one-colour design (different from the frame color) A9000100171-998 € 280.50

Colour: _____

A9000100170-

Caster wheel: 5" aluminium rim² (3-spoke design)

Frame colour A9000100174-999 € 73.00

Select from one-colour design (different from the frame color) A9000100174-998 € 84.60

Colour: _____

A9000100170-

Special colour requests (frame or attachment parts)

Frame colour for single purchasing

Selection from RAL colour palette

A9000100170-100 € 402.30

Gloss level

gloss

matt

colour name

RAL number

Note: attachment parts are **not** possible in design colors

¹ Only in conjunction with Liteline hub (with drive wheel aluminum rim with 18 or 36 spokes, single rim)

² Only in conjunction with caster wheel 5" aluminum rim 3-spoke design good shock absorption A900050121*, as well as with suspension fork 5-spoke design A9000500160*

Backrest

Aluminum side guard, contour following the wheel

A9015402470-002

Backrest screwed, not foldable, back angle 90° to the floor
Adapted to the upper edge of the tyre in frame colour

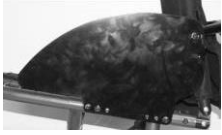

Aluminum side guard, contour by indicated dimension

A9015402470-001 € 162.80

Bolted backrest, cannot be folded
Indicated dimension:

A = _____ cm / B = _____ cm
in frame colour

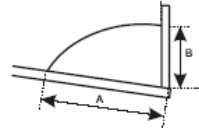

Side part with welded tubular bracket, contour following the wheel

A9011400400-002 € 441.00

with filling plate
Bolted backrest, cannot be folded
Adapted to the upper edge of the tyre in frame colour
(details 3 cm above the tyre)
Not in combination with Body Contour in frame colour



Side part with welded tubular bracket, contour by indicated dimension

A9011400400-001 € 509.30

with filling plate
Bolted backrest, cannot be folded
Adapted to the upper edge of the tyre, in frame colour

Indicated dimension:

A = _____ cm / B = _____ cm

Not in combination with Body Contour

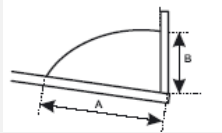

Folding backrest

A9011400010 € 313.80

7-way angle adjustable, with integrated plastic-coated aluminum side parts



Back equipment

If not specified, the "Adaptable back with back padding" will be delivered.

Adaptable back with back padding

A9000802010-K

Cover: Black, breathable, open surface
Equipment with back cross bar



For other back systems for example ergonomic back shell, see separate order sheet: "PRO ACTIV seat and back systems"



Seat upholstery

If not specified, the "Body Contour seat upholstery" will be delivered.

Body Contour

A9000801025-K
approved up to a body weight of 120 kg
Not in combination with side part with welded
tubular bracket, item no. A9011400400-001
and A9011400400-002

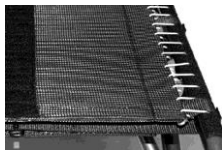

Open belt system

A9000801010-K € 74.70

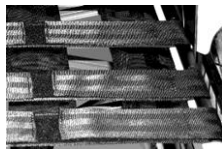

Seat cushion

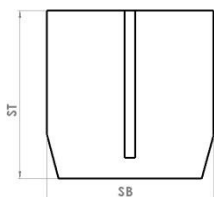

**Seat cushion for individual frame
geometry in rectangular contour**
Inlet: Standard

A9000805190-K € 156.70

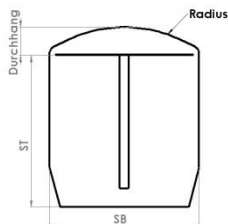

**Seat cushion for individual frame
geometry with radius contour**
Inlet: Standard

A9000805320-K € 200.10

Seat cushion height:

3 cm 5 cm
 4 cm 6 cm

**Seat cushion for individual frame
geometry in rectangular contour**
Inlet: Anti-Decubitus

A9000805210-K € 467.40

**Seat cushion for individual frame
geometry with radius contour**
Inlet: Anti-Decubitus

A9000805310-K € 510.40

Seat cushion height:

4 cm
 6 cm

Cover:

Black, breathable, open surface

Black, breathable, closed surface

If no specification is made, the cover material "Black, breathable, open surface" will be delivered.

Seat cushion is existing

You can also find the seat cushions on our separate order sheet: "PRO ACTIV seat and backrest systems"

Wheel camber

12° drive wheel camber

A9011202000-012

15° drive wheel camber

A9011202000-015

18° drive wheel camber

A9011202000-018

20° drive wheel camber

A9011202000-020

Footrest

If not specified, the "continuous footrest" will be delivered.

Continuous footrest

A9016601010-K001
with tubular resting bracket
height adjustable +/- 3 cm



Continuous footrest with rubber coated footplate

A9011610000-K € 117.40
height adjustable +/- 3 cm
Rest: Edge-folded at front, bolted
Depth: 27 cm



Continuous footrest with "Box-Form" footplate support

A9011610020 € 208.30
rubber coated, height adjustable +/- 3 cm,
Rest:
Width: 20 cm,
Length: 31.5 cm + 1.5 cm adjustable



Ram bar

Offence bar with radius arch

A9011100500 € 341.30

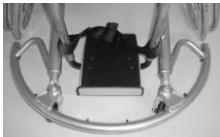

Offence bar with trapezoid shape

A9011100501 € 341.30

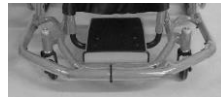

Defence bar, removable

A9011100502 € 341.30



Rear ram bar

A9011100600 € 283.50
carried out as bent tube



Adaptations

Central anti-tipping support oversized Permanently welded

- Anti-tipping fork with screwed axle A9011300378 € 348.10
- Anti-tipping fork removable via floating axle A9011300374 € 390.20



2 anti-tipping supports with oversized tube

- Anti-tipping fork with screwed axle A9011300170 € 451.00
- Anti-tipping fork removable via floating axle A9011300270 € 569.70



Central anti-tipping support with oversized tube, length adjustable (tennis)

- A9011300370 € 428.70
with permanently mounted tipping wheel rotary fork



4 Dance central anti-tipping support

A9000300010 € 502.30

removable via quick release lever with rotating
caster fork and skate wheel Ø 80 mm
adjustable ground clearance and angle
Colour: black



3" caster wheel

3" safety light-up wheel (80 mm)

A9000501110 € 68.70

puncture-proof



Drive wheels

Information about other rim types, designs and availability can be found at: www.proactiv-gmbh.de.
If not specified, the "drive wheel 36 spokes aluminum rim" will be delivered.

Drive wheel 36-spoke aluminum rim

24" (ETRTO 540)
A9000203000-010
with Liteline hub (left image),
radially spoked
up to 120 kg body weight

24" (ETRTO 540)
A9000203000-020
with aluminum front hub (right image),
radially spoked
over 120 kg body weight



Drive wheel double rim 36-spokes

24" (ETRTO 540) € 153.20
A9000203100

25" (ETRTO 559) € 153.20
A9000203200

26" (ETRTO 590) € 153.20
A9000203300

28" (ETRTO 622) € 153.20
A9000203310

with aluminum front hub, radially spoked
Use with higher loads and body weight
> 120 kg

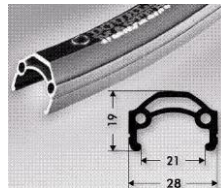

Spinergy wheel "Spox Sport" with 24 PBO spokes; rim, hub and spokes in black

24" (ETRTO 540) € 761.30
A9000203550

25" (ETRTO 559) € 761.30
A9000201559

26" (ETRTO 590) € 761.30
A9000203555



Handrims

x = dimension handrim attachment

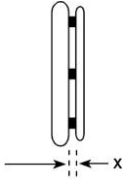

Handrim attachment
general:

x = 11 mm

x = 19 mm

If not specified, the handrim will be mounted wide (19 mm).

Stainless steel Ø 20 mm

24" handrim for
24" wheel and 25" wheel
A9000205010-004

26" handrim for
26" wheel
A9000205010-006

28" handrim for
28" wheel
A9000205010-008



Aluminum Ø 19 mm silver anodised

24" handrim for
24" wheel and 25" wheel
A9000205019-004



Aluminum Ø 19 mm polished and hard-anodised

24" handrim for
24" wheel and 25" wheel € 160.10
A9000205030-004

26" handrim for
26" wheel € 160.10
A9000205030-006



Titanium Ø 19 mm

24" handrim for
24" wheel and 25" wheel € 325.80
A9000205040-004

26" handrim for
26" wheel € 325.80
A9000205040-006



Silicone handrim cover

for 24" handrim € 226.00
A9000205100-004

for 26" handrim € 226.00
A9000205100-006

Surface without structure,
compatible with handrim Ø 19 mm or
Ø 20 mm.



Spoke guard

Finger- and spoke guard "transparent"

for 24" wheel € 201.10
A9000206300-004

for 26" wheel € 201.10
A9000206300-006

Not in combination with Spinergy drive wheels.



Tyres

If not specified, the "Schwalbe RightRun in black" tyres will be delivered.

Schwalbe „RightRun“ High-pressure tyres

- 24x1" (540-25)
A9000204001-004

Colour: Black
7.5 bar



Schwalbe „RightRun“ High-pressure tyres

- 24x1" (540-25)
A9000204000-004

- 25x1" (559-25)
A9000204000-005

- 26x1" (590-25)
A9000204000-006

Colour: Grey, black wall
7.5 bar



28x1" high-pressure lightweight

- A9000204000-008
(ETRTO 622-28)
Colour: Grey, black wall
7.5 bar

Accessories

Hand air compressor with pressure gauge

- A9000901100 € 103.20
up to 14 bar



Transport bag for drive wheels

- for 24" wheel
A9000903530-004 € 75.50
Ø 76 cm x 2 cm
- for 26" wheel
A9000903530-006 € 75.50
Ø 83 cm x 2 cm



Further accessories (such as handbikes, steering attachments, etc.) see separate order form or www.proactiv-gmbh.de.

Notes and remarks:

Location, Date

The signature field is intended for the consultant and insured person. This confirms that the intended equipment is intended for the insured person.

Signature End customer/dealer