



## SPEEDY A1

### Active easy running rigid frame wheelchair

Maximum user weight limit 120 kg

A9010100000 € 4,010.00

**Quotation date:** \_\_\_\_\_

**Consultation was carried out by  
Staff at the medical supplies shop:** \_\_\_\_\_

**Order date:** \_\_\_\_\_

according to GTC PRO ACTIV Reha-Technik GmbH

#### Medical suppliers / company address:

Cust. no.: \_\_\_\_\_  
Name: \_\_\_\_\_  
Street: \_\_\_\_\_  
Postcode / city: \_\_\_\_\_  
Phone: \_\_\_\_\_  
Fax: \_\_\_\_\_  
E-Mail: \_\_\_\_\_  
Contact: \_\_\_\_\_

**Shipping address:**  **same as company address**  
 **Other (see below)**

Name: \_\_\_\_\_  
Street: \_\_\_\_\_  
Postcode / city: \_\_\_\_\_

#### Customer name / commission:

Surname, forename: \_\_\_\_\_  
Street: \_\_\_\_\_  
Postcode / city: \_\_\_\_\_  
Phone: \_\_\_\_\_  
Fax: \_\_\_\_\_  
E-Mail: \_\_\_\_\_  
D.O.B: \_\_\_\_\_  
Paying organisation: \_\_\_\_\_

**Invoicing address:**  **same as company address**  
 **other (see below)**

Cust. no.: \_\_\_\_\_  
Name: \_\_\_\_\_  
Street: \_\_\_\_\_  
Postcode / city: \_\_\_\_\_  
Phone: \_\_\_\_\_  
Fax: \_\_\_\_\_  
E-Mail: \_\_\_\_\_  
Contact: \_\_\_\_\_

# Basic size

## Body size:

Body height: \_\_\_\_\_ cm

Weight: \_\_\_\_\_ cm

Lower leg length: \_\_\_\_\_ cm

(anatomic dimension: hollow of the knee to the foot sole)

Indication: \_\_\_\_\_

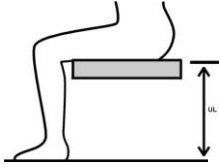

This information is necessary for checking. If the information is missing, a check of the relevant items cannot be made!

## Wheelchair dimensions:

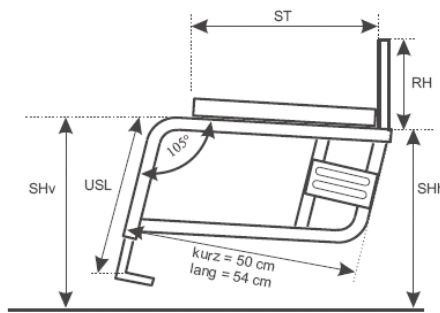

<b>Seat width SB</b>	<input type="checkbox"/> 30 <input type="checkbox"/> 31 <input type="checkbox"/> 32 <input type="checkbox"/> 33 <input type="checkbox"/> 34 <input type="checkbox"/> 35 <input type="checkbox"/> 36 <input type="checkbox"/> 37 <input type="checkbox"/> 38 <input type="checkbox"/> 39 <input type="checkbox"/> 40 <input type="checkbox"/> 41 <input type="checkbox"/> 42 <input type="checkbox"/> 43 <input type="checkbox"/> 44 <input type="checkbox"/> 45 <input type="checkbox"/> 46 <input type="checkbox"/> 47 <input type="checkbox"/> 48 <input type="checkbox"/> 49 <input type="checkbox"/> 50									
<b>Seat depth ST</b>	<b>Short frame</b> <input type="checkbox"/> 36 <input type="checkbox"/> 37 <input type="checkbox"/> 38 <input type="checkbox"/> 39 <input type="checkbox"/> 40 <input type="checkbox"/> 41 <input type="checkbox"/> 42 <input type="checkbox"/> 43				<b>Long frame</b> <input type="checkbox"/> 40 <input type="checkbox"/> 41 <input type="checkbox"/> 42 <input type="checkbox"/> 43 <input type="checkbox"/> 44 <input type="checkbox"/> 45 <input type="checkbox"/> 46 <input type="checkbox"/> 47 <input type="checkbox"/> 48					
<b>Back height RH</b>	<input type="checkbox"/> 20 <input type="checkbox"/> 21 <input type="checkbox"/> 22 <input type="checkbox"/> 23 <input type="checkbox"/> 24 <input type="checkbox"/> 25 <input type="checkbox"/> 26 <input type="checkbox"/> 27 <input type="checkbox"/> 28 <input type="checkbox"/> 29 <input type="checkbox"/> 30 <input type="checkbox"/> 31 <input type="checkbox"/> 32 <input type="checkbox"/> 33 <input type="checkbox"/> 34 <input type="checkbox"/> 35 <input type="checkbox"/> 36 <input type="checkbox"/> 37 <input type="checkbox"/> 38 <input type="checkbox"/> 39 <input type="checkbox"/> 40 <input type="checkbox"/> 41 <input type="checkbox"/> 42 <input type="checkbox"/> 43 <input type="checkbox"/> 44 <input type="checkbox"/> 45 <input type="checkbox"/> 46 <input type="checkbox"/> 47 <input type="checkbox"/> 48									
<b>Lower leg length USL</b>	<b>Short frame</b> <input type="checkbox"/> 33 <input type="checkbox"/> 34 <input type="checkbox"/> 35 <input type="checkbox"/> 36 <input type="checkbox"/> 37 <input type="checkbox"/> 38 <input type="checkbox"/> 39 <input type="checkbox"/> 40 <input type="checkbox"/> 41 <input type="checkbox"/> 42 <input type="checkbox"/> 43 <input type="checkbox"/> 44 <input type="checkbox"/> 45 <input type="checkbox"/> 46 <input type="checkbox"/> 47 <input type="checkbox"/> 48 <input type="checkbox"/> 49 <input type="checkbox"/> 50					<b>Long frame</b> <input type="checkbox"/> 35 <input type="checkbox"/> 36 <input type="checkbox"/> 37 <input type="checkbox"/> 38 <input type="checkbox"/> 39 <input type="checkbox"/> 40 <input type="checkbox"/> 41 <input type="checkbox"/> 42 <input type="checkbox"/> 43 <input type="checkbox"/> 44 <input type="checkbox"/> 45 <input type="checkbox"/> 46 <input type="checkbox"/> 47 <input type="checkbox"/> 48 <input type="checkbox"/> 49 <input type="checkbox"/> 50 <input type="checkbox"/> 51 <input type="checkbox"/> 52				
<b>Seat height back SHh</b> (for 24" drive wheels)	<b>Short frame</b> <input type="checkbox"/> 37 <input type="checkbox"/> 38 <input type="checkbox"/> 39 <input type="checkbox"/> 40 <input type="checkbox"/> 41 <input type="checkbox"/> 42 <input type="checkbox"/> 43				<b>Long frame</b> <input type="checkbox"/> 39 <input type="checkbox"/> 40 <input type="checkbox"/> 41 <input type="checkbox"/> 42 <input type="checkbox"/> 43 <input type="checkbox"/> 44 <input type="checkbox"/> 45					
<b>Seat height front SHv</b> (for 5" caster wheel)	<b>Short frame</b> <input type="checkbox"/> 44 <input type="checkbox"/> 45 <input type="checkbox"/> 46 <input type="checkbox"/> 47 <input type="checkbox"/> 48 <input type="checkbox"/> 49 <input type="checkbox"/> 50 <input type="checkbox"/> 51 <input type="checkbox"/> 52					<b>Long frame</b> <input type="checkbox"/> 46 <input type="checkbox"/> 47 <input type="checkbox"/> 48 <input type="checkbox"/> 49 <input type="checkbox"/> 50 <input type="checkbox"/> 51 <input type="checkbox"/> 52 <input type="checkbox"/> 53 <input type="checkbox"/> 54				
<b>Tipping point KP</b> (front side rear tube to axis middle drive wheel)	<input type="checkbox"/> 4 <input type="checkbox"/> 5 <input type="checkbox"/> 6 <input type="checkbox"/> 7 <input checked="" type="checkbox"/> 8 <input type="checkbox"/> 9 <input type="checkbox"/> 10 <input type="checkbox"/> 11 <input type="checkbox"/> 12 <input type="checkbox"/> 13									

Please select the required dimensions (all dimensions are in cm).

The underlined values are the standard settings.

The values SHh and SHv may deviate from the specified values depending on the wheel size and wheel camber!

## Frame colour - one-colour design

Information on current colour designs and example images at: [www.proactiv-gmbh.de/farben.php](http://www.proactiv-gmbh.de/farben.php)

### Frame colour: Selection from colour palette

Frame colour will be specified with order

A9000100170-000

Raw, blasted, not coated

A9000100170-020

Note: In combination with moisture e.g. hand perspiration, can affect dark aluminum discoloration.

### Powder colours

**White RAL 9016**

gloss A9000100170-023

matt A9000100170-123 € 42.10

**Brilliant silver**

gloss A9000100170-011

**Anthracite RAL 7016**

gloss A9000100170-001

matt A9000100170-101 € 42.10

**Black RAL 9005**

gloss A9000100170-003

matt A9000100170-019 € 42.10

**Pure orange RAL 2004**

gloss A9000100170-022

matt A9000100170-122 € 42.10

**Pink magenta RAL 4010**

gloss A9000100170-037

matt A9000100170-137 € 42.10

**Pastel blue RAL 5024**

gloss A9000100170-036

matt A9000100170-136 € 42.10

**Lemon green**

gloss A9000100170-005

matt A9000100170-105 € 42.10

**Yellow RAL 1023**

gloss A9000100170-046

matt A9000100170-146 € 42.10

**Red RAL 3001**

gloss A9000100170-047

matt A9000100170-147 € 42.10

**Lagoon blue**

gloss A9000100170-052

matt A9000100170-152 € 42.10

**Athletic grey**

gloss A9000100170-050

matt A9000100170-150 € 42.10

**Muddy grey**

gloss A9000100170-051

matt A9000100170-151 € 42.10

### Powder colours „Dormant“

**Deep black effect silver**

gloss A9000100170-007

**Sky blue**

gloss A9000100170-017

**Navy blue**

gloss A9000100170-045

matt A9000100170-145 € 42.10

**Electric green**

gloss A9000100170-015

matt A9000100170-115 € 42.10

**Violet**

gloss A9000100170-044

**Fire red**

gloss A9000100170-018

matt A9000100170-118 € 42.10

## Frame colour - One-colour design special colours “liquid coating”

€ 339.40

**Storm (ice blue)**

gloss A9000100170-500

matt A9000100170-501

**Coffee**

gloss A9000100170-520

matt A9000100170-521

**Prairie (rose gold)**

gloss A9000100170-504

matt A9000100170-505

**Pearl (mother of pearl-white)**

gloss A9000100170-524

matt A9000100170-525

**Berry**

gloss A9000100170-526

matt A9000100170-527

**Blue ocean**

gloss A9000100170-522

matt A9000100170-523

**Emerald**

gloss A9000100170-514

matt A9000100170-515

**Mint**

gloss A9000100170-528

matt A9000100170-529

**Chili**

gloss A9000100170-516

matt A9000100170-517

## Frame colour - Two-colour design

Note: In the two-colour design, both colours are the same gloss level as the design colour.

**Two-colour design with one base colour (on the rear frame) and one design colour (on the front frame)** € 260.70

Please select a color from below:

### Base colour (on the rear frame)

#### White RAL 9016

A9000100170-200

#### Brilliant silver

A9000100170-201

#### Anthracite RAL 7016

A9000100170-202

#### Black RAL 9005

A9000100170-203

#### Pastel blue RAL 5024

A9000100170-206

#### Lemon green

A9000100170-207

#### Yellow RAL 1023

A9000100170-208

#### Lagoon blue

A9000100170-212

#### Athletic grey

A9000100170-210

#### Muddy grey

A9000100170-211

### Design colour (on the front frame)

#### Black RAL 9005

gloss A9000100170-259

matt A9000100170-260

#### Lemon green

gloss A9000100170-250

matt A9000100170-251

#### Chili

gloss A9000100170-253

matt A9000100170-254

#### Pure orange RAL 2004

gloss A9000100170-255

matt A9000100170-256

#### Coffee

gloss A9000100170-278

matt A9000100170-279

#### Mint

gloss A9000100170-286

matt A9000100170-287

#### Emerald

gloss A9000100170-274

matt A9000100170-275

#### Storm (ice blue)

gloss A9000100170-264

matt A9000100170-265

#### Prairie (rose gold)

gloss A9000100170-266

matt A9000100170-267

#### Pearl (mother of pearl-white)

gloss A9000100170-282

matt A9000100170-283

#### Berry

gloss A9000100170-284

matt A9000100170-285

#### Blue ocean

gloss A9000100170-280

matt A9000100170-281

## Colour - Attachment parts

Note: If not specified, the caster fork and bearing block will be mounted in black.

### Drive wheel: aluminum rim, hub and spokes

Black A9000100171-003

### Caster fork and bearing block

Silver A9000100173-011

Black A9000100173-003

## Colour design of attachment parts according to customer request:

### Drive wheel: Aluminium rim and design inlet<sup>1</sup>

Frame colour A9000100171-999 € 242.30

Select from one-colour design (different from the frame color) A9000100171-998 € 280.50

Colour: \_\_\_\_\_

A9000100170-

### Caster wheel: 5" aluminium rim<sup>2</sup> (3-spoke design)

Frame colour A9000100174-999 € 73.00

Select from one-colour design (different from the frame color) A9000100174-998 € 84.60

Colour: \_\_\_\_\_

A9000100170-

## Special colour requests (frame or attachment parts)

### Frame colour for single purchasing

#### Selection from RAL colour palette

A9000100170-100 € 402.30

### Gloss level

gloss

matt

### colour name

\_\_\_\_\_

### RAL number

\_\_\_\_\_

**Note:** attachment parts are **not** possible in design colors

<sup>1</sup> Only in conjunction with Liteline hub (with drive wheel aluminum rim with 18 or 36 spokes, single rim)

<sup>2</sup> Only in conjunction with caster wheel 5" aluminum rim 3-spoke design good shock absorption A900050121\*, as well as with suspension fork 5-spoke design A9000500160\*

## Frames

### Straight front end

A9010100010-K\*



### Front end V-shape

A9010100020-K\* € 249.50

from SB 33 cm  
Note: Footrest area with V-shape  
 $x = SB - (0.25 \times USL + 6 \text{ cm})$

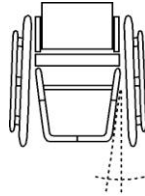

## Front frame angle

### Knee angle 105°

A9000100050-001

### Knee angle 95°

A9000100050-002 € 329.10

## Rear frame angle

### Rear frame angle 105°

A9010100100-001  
KP from 6 cm to 13 cm

### Rear frame angle 95°

A9010100100-002 € 125.40  
KP from 4 cm to 10 cm

## Push handles

### Back tube with integrated handles

A9000401051-K € 126.60  
straight



### Aluminum push handles fixed in back tube

A9000401050 € 126.60  
from RH 23 cm



### Horizontal push handles screwed into the back tube

A9000401076 € 234.80  
can be unscrewed



### Safety push handles height adjustable

A9000401060\* € 210.10

Mount in the back tube  
from RH 30 cm with adaptable back  
from RH 35 cm for back tube with lordosis support  
from RH 43 cm with back shell



### Safety push handles back-positioned length 45 cm

A9000401075 € 362.00

continuous height adjustment,  
Safety push handle holder mounted on the back cross bar  
Up to SB 42 cm or body weight 95 kg  
Not in combination with swing-away armrest



### Equipment without push handles

A9000401000



## Backrest

### Folding backrest

A9000400011  
7-way angle adjustable,  
with integrated plastic-coated aluminum side  
parts



### Back tube with lordosis support

- A9000400005-K € 111.10
- 1 cm  
 2 cm  
 3 cm



## Back equipment

If not specified, the "Adaptable back with back padding" will be delivered.

### Adaptable back with back padding

A9000802010-K  
Cover: Black, breathable, open surface  
Equipment with back cross bar



### Back rise + 3 - 5 cm

A9000802100 € 151.60  
for the nominal back height dimension  
Only in combination with height-adjustable  
push handles



### Equipment without back upholstery and back padding or back system

A9000802011 € - 53.00  
Equipment with back cross bar

For other back systems for example ergonomic back shell, see  
separate order sheet: "PRO ACTIV seat and back systems"



You will find our PRO ACTIV transport restraint systems  
on our separate "Transport restraint systems" order sheet



## Seat upholstery

If not specified, the "Body Contour seat upholstery" will be delivered.

### Body Contour

A9000801025-K  
approved up to a body weight of 120 kg

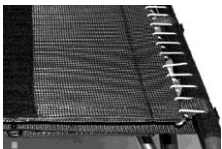

### Open belt system

A9000801010-K € 74.70

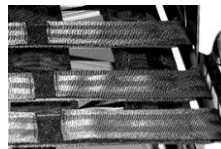

### Equipment without seat upholstery

A9000801050



## Seat cushion

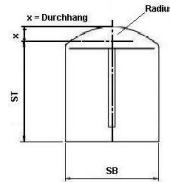
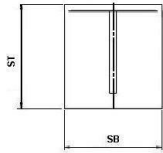

### Seat cushion in rectangular contour Inlet: Standard

A9000805180-K\* € 111.90

### Seat cushion with radius contour Inlet: Standard

A9000800300-K\* € 155.40

### Seat cushion height:

3 cm       5 cm  
 4 cm       6 cm

### Seat cushion in rectangular contour Inlet: Anti-Decubitus

up to 30x30 cm  
A9000805204-K\* € 290.00

>30x30 up to 50x50 cm  
A9000805200-K\* € 422.00

### Seat cushion with radius contour Inlet: Anti-Decubitus

up to 30x30 cm  
A9000800311-K\* € 342.80

>30x30 up to 50x50 cm  
A9000800310-K\* € 465.90

### Seat cushion height:

4 cm  
 6 cm

### Cover:

- Black, breathable, open surface  
 Black, breathable, closed surface

If no specification is made, the cover material "Black, breathable, open surface" will be delivered.

Seat cushion is existing

You can also find the seat cushions on our separate order sheet: "PRO ACTIV seat and backrest systems"

## Clothing guard

### Aluminum clothing guard removable via lock function

Adjustable following wheel arch  
Only in combination with folding backrest



in anthracite matt

A9000403210-K € 236.10

in frame colour (basic colour with two-colour design)

A9000403211-K € 302.00

in design colour (only possible with frame colour in two-colour design)

A9000403212-K € 335.00

### Carbon clothing guard removable via lock function

A9000400012-K € 547.30

Adjustable following wheel arch  
Only in combination with folding backrest



## Armrests

### Armrest, height adjustable, integrated in the clothing guard

Including aluminum clothing guard  
with arm padding 25 cm long  
Removable via lock function  
Only in combination with folding backrest



in anthracite matt

A9000400008-K € 553.00

in frame colour (basic colour with two-colour design)

A9000400009-K € 603.80

in design colour (only possible with frame colour in two-colour design)

A9000400010-K € 629.20

<p><b>Armrest, height adjustable, integrated in the clothing guard</b></p> <p><input type="checkbox"/> A9000400018-K      € 836.90</p> <p>Including carbon clothing guard with arm padding 25 cm long Removable via lock function Only in combination with folding backrest</p>	<p><b>Armrests folding up, removable</b></p> <p><input type="checkbox"/> A9000403141-K      € 348.10</p> <p>with arm padding 25 cm long Positioning: upper arm padding edge approx. 25 to 31 cm above the seat tube, adjustable in 1.5 cm steps Not possible in combination with back-positioned safety push handles</p> 	<p><b>DESK side part with armrest 38 cm</b></p> <p><input type="checkbox"/> A9010403160      € 465.50</p> <p>removable, height-adjustable (Overall width + 4 cm) Not possible in combination with aluminum / carbon clothing guard</p>
---	--	--

## Axle plate

Standard equipment with 12 mm sockets/axles. Further axle plates on request.

### 2-slot axle plate

A9000201000\*

Seat height back (with 24" wheel):  
short frame = approx. 37 - 43 cm  
long frame = approx. 39 - 45 cm



### 3-slot axle plate

A9000201020\*      € 169.60

Seat height back (with 24" wheel):  
short frame = approx. 40 - 46 cm  
long frame = approx. 42 - 48 cm

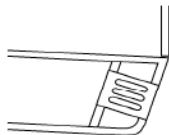

### Extended wheel plate

A9000201010\*      € 169.60

Wheelbase extension by 7.5 cm  
short frame = approx. 37 - 43 cm  
long frame = approx. 39 - 45 cm



### Extended bike plate

A9000201030\*      € 306.00

+4° camber integrated, adjustable track  
short frame = approx. 37 - 43 cm  
long frame = approx. 39 - 45 cm

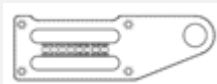

## Wheel camber

\*Total width with tight-mounted handrim.

### 1° drive wheel camber

A9000202010\*

Total width = approx. SB + 20 cm\*

### 4° drive wheel camber

A9000202030\*

Total width = approx. SB + 26 cm\*

### 6° drive wheel camber

A9000202040\*

Total width = approx. SB + 30 cm\*

## E-Adaptations

### Preparation for the "e-motion" / „e-motion DuoDrive“ mounting

A9000201200      € 488.30

Equipment: e-motion torque support, 1/2" axle and socket length 50.8 mm (2")  
PRO ACTIV and Alber recommend anti-tipping supports are installed in pairs. Please choose "Adaptations" under the selection.

### Preparation for the "e-fix" mounting

A9000201210      € 488.30

Equipment: 1/2" axle, socket length 50.8 mm (2") and e-fix torque support.  
PRO ACTIV and Alber recommend anti-tipping supports are installed in pairs. Please choose "Adaptations" under the selection.  
Please order Alber anti-tipping supports and corresponding components direct from Alber.



## Brake system

If not specified, the "Brake system push to lock with standard brake handle" will be delivered.

**Recommendation:** For KP 7 cm or lower, we recommend the „Brake system push to lock with brake handle 20° outwards“.

### Brake system push to lock Standard brake handle

A9000701010-001



### Brake system push to lock Long brake handle

A9000701010-002



### Brake system push to lock Low brake handle

A9000701010-003



### Brake system push to lock Brake handle 20° outwards

Standard brake handle  
A9000700002

Long brake handle  
A9000701010-004



### Brake system push to lock Brake handle to flip-down

A9000706008      € 154.00  
Length: 9 cm



### Drum brake

A9000702011-K\*      € 460.20

Operating from the push handle  
Total wheelchair width (see selection "Wheel  
camber") + 3 cm  
Depending on the seat height, the 2-slot wheel  
plate A9000201000\* is mounted in order to  
protect the drum brake anchors.  
Please note:  
- Only in combination with drive wheel  
aluminum 36-spoke rim wheel  
- Not in combination with one-hand drive,  
e-fix or e-motion



## Footrest

If not specified, the "continuous footrest" will be delivered.

### Continuous footrest

A9016601010-K\*  
with tubular resting bracket  
height adjustable +/- 3 cm  
If the footrest is wanted with a "rubber coated  
footplate", please select this under "Footrest  
accessories"



### Footrest folding up to one side

A9016601300-K\*      € 168.80  
with continuous tubular resting bracket,  
height adjustable +/- 3 cm,  
can be swung away,  
cannot be removed  
for KW 95° from USL 35 cm  
for KW 105° from USL 40 cm  
with V-shape from SB 40 cm  
If the footrest is wanted with a "rubber coated  
footplate", please select this under "Footrest  
accessories"



### Footrest folds up to the rear with spring locking mechanism

A9016602005-K\*      € 279.00  
with tubular resting bracket  
from USL 40 cm  
only with V-shape and long frame  
If the footrest is wanted with a "rubber coated  
footplate", please select this under "Footrest  
accessories"





<p><b>Footrest folds up to the rear</b></p> <p><input type="checkbox"/> A9016602010-K*      € 298.90</p> <p>with tubular resting bracket and 20 mm operating lever for KW 95° from USL 38 cm for KW 105° from USL 42 cm straight front end from SB 33 cm V-shape from SB 38 cm If the footrest is wanted with a "rubber coated footplate", please select this under "Footrest accessories"</p> 	<p><b>Divided footrest</b></p> <p><input type="checkbox"/> A9016603200-K      € 327.00</p> <p>with rubber coated footplate, height adjustable +/- 3 cm, angle adjustment, can be pivoted outwards and folded up to the side including frame reinforcement V-shape from SB 40 cm</p> 	<p><b>"Swing Away" footrest</b></p> <p><input type="checkbox"/> A9016604100-K      € 392.90</p> <p>with rubber coated footplate, separated in the middle, can be folded to the side, removable, can be folded up, height-adjustable, angle-adjustable including frame reinforcement from USL 34 cm</p> 
---	---	--

**Footrest accessories**

<p><b>Rubber coated footplate</b></p> <p><input type="checkbox"/> A9000610000-K      € 122.20</p> <p>bolted, angle-adjustable Depth: 14 cm</p> 	<p><b>Footrest side stop</b></p> <p><input type="checkbox"/> A9000610100      € 58.00</p> <p>adjustable only in combination with rubber coated footplate</p> 	
---	--	--

**Adaptations**

<p><b>Anti-tipping support</b></p> <p><input type="checkbox"/> right side      € 164.20 A9000300110-K*</p> <p><input type="checkbox"/> left side      € 164.20 A9000300111-K*</p> <p>with tension spring and universal adapter pivotable For optimum pivoting behaviour, the seat slope should be &gt; 3 cm</p> 	<p><b>Transit wheels</b></p> <p><input type="checkbox"/> A9000301110-K*      € 320.00</p> <p>with universal adapter, removable not in combination with anti-tipping support</p> 	<p><b>Tilting clamp</b></p> <p><input type="checkbox"/> right side      € 136.00 A9000302110*</p> <p><input type="checkbox"/> left side      € 136.00 A9000302111*</p> <p>with universal adapter and Quick pin not in combination with anti-tipping support, right side or left side</p> 
--	---	--

**3" caster wheel**

<p><b>3" safety light-up wheel (80 mm)</b></p> <p><input type="checkbox"/> A9000501110      € 68.70</p> <p>puncture-proof</p> 	
--	--

## 4" caster wheel

### 4" caster wheel „Standard“ solid rubber black

A9000501011-004  
(82A), puncture-proof



### 4" Skate wheel (100 mm)

A9000501120 € 68.70  
puncture-proof



### 4" safety light-up wheel (100 mm)

A9000501220 € 92.00  
puncture-proof



### 4" Frog Legs caster wheel (100 mm)

A9000501230 € 206.30  
with replaceable rubber 6 mm, puncture-proof  
Colour: black, silver rim  
Incl. hair guard spacer (5.3 mm)



## 5" caster wheel

### 5" caster wheel „Standard“ PU black

A9000501036-005  
(82A), puncture-proof



### 5" caster wheel „Standard“ PU grey

A9000501031-005  
(82A), puncture-proof



### 5" safety light-up wheel (125 mm)

A9000501221 € 92.00  
puncture-proof



### 5" aluminum rim 3-spoke design “good shock absorption”

Silver A9000501210 € 174.60  
 Black A9000501211 € 174.60  
with replaceable rubber 6 mm medium hard,  
puncture-proof  
Incl. hair guard spacer (3 mm)



### 5" Frog Legs caster wheel (125 mm)

A9000501232 € 206.30  
with replaceable rubber 6 mm, puncture-proof  
Colour: black, silver rim  
Incl. hair guard spacer (5.3 mm)



## 6" caster wheel

### 6" caster wheel „Standard“ PU grey

A9000501010-006  
(82A), puncture-proof



### 6" caster wheel “pneumatic tyre”

A9000501050 € 55.50  
SH front min. 42 cm



### 6" caster wheel “Flexel System”

A9000501070 € 55.50  
puncture-proof



## Caster fork

If not specified, the "standard caster fork with screw axle" is supplied.

### Caster fork Standard

A9000500100-K001  
with screwed axle

A9000500100-K002      € 162.50  
with quick-release axle



### Caster fork Heavy Duty for high loads

Extra weight approx. 100 - 150 gr.

A9000510111-K001      € 52.40  
with screwed axle

A9000510111-K002      € 212.50  
with quick-release axle



### Suspension fork

inkl. 5" aluminum rim "good shock absorption"

A9000500160-K002      € 598.90  
with quick-release axle



### Caster fork spare wheel „Standard“

A9000500300-K      € 288.10  
Caster fork Standard with quick-release axles



### Caster fork spare wheel „Heavy Duty“

A9000500301-K      € 328.10  
Caster fork Heavy Duty with quick-release axles



The spare caster fork does not have a caster wheel.  
In case a caster wheel is requested, please put a cross on a second selection in the category "Caster wheels".

## Track distance

### Caster wheel track extension



A9000500400\*      € 57.40  
10 mm per side

A9000500401\*      € 57.40  
15 mm per side

A9000500410\*      € 57.40  
20 mm per side

## Drive wheels

Information about other rim types, designs and availability can be found at: [www.proactiv-gmbh.de](http://www.proactiv-gmbh.de).  
If not specified, the "drive wheel 36 spokes aluminum rim" will be delivered.

### Drive wheel 18-spoke aluminum rim

- 24" (ETRTO 540)  
A9000203122  
with Liteline hub, radially spoked  
Not in combination with:  
- Puncture-proof tyres  
- One-hand drive  
- Drum brake  
- Transport restraint connection  
- Handbike  
up to 70 kg body weight:

Sturz	Gewicht				
	1°	4°	6°	8°	10°
bis 50 Kg	✓	✓	✓	✓	✓
51 - 60 Kg	✓	✓	✓	✓	
61 - 70 Kg	✓	✓			



### Drive wheel 36-spoke aluminum rim

- 24" (ETRTO 540)  
A9000203000-010  
with Liteline hub (left image),  
radially spoked  
up to 120 kg body weight
- 24" (ETRTO 540)  
A9000203000-020  
with aluminum front hub (right image),  
radially spoked  
over 120 kg body weight



### Drive wheel double rim 36-spokes

- 24" (ETRTO 540)  
A9000203100 € 153.20
- 25" (ETRTO 559)  
A9000203200 € 153.20
- 26" (ETRTO 590)  
A9000203300 € 153.20  
with aluminum front hub,  
radially spoked  
Use with higher loads and body weight  
> 120 kg



### Spinergy wheel "Spox Sport" with 24 PBO spokes; rim, hub and spokes in black

- 24" (ETRTO 540) € 761.30  
A9000203550
- 25" (ETRTO 559) € 761.30  
A9000201559
- 26" (ETRTO 590) € 761.30  
A9000203555



### Spinergy „Everyday Light Extreme“ with 12 PBO spokes; rim and hub in black, spokes in white

- 24" (ETRTO 540) € 929.30  
A9000203554  
Recommendation: up to 70 kg body weight,  
not in combination with handbike/traction  
device use.



### Spinergy „Everyday Light Extreme“ with 12 PBO spokes; rim, hub and spokes in black

- 24" (ETRTO 540) € 929.30  
A9000203552  
Recommendation: up to 70 kg body weight,  
not in combination with handbike/traction  
device use.



# Handrims

x = dimension handrim attachment

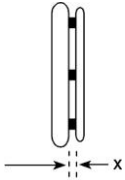

Handrim attachment  
general:

- x = 11 mm
- x = 19 mm

Handrim attachment  
Curve + Gekko handrim:

- x = 10 mm
- x = 18 mm

If not specified, the handrim will be mounted wide (19 mm / 18 mm).

## Stainless steel Ø 20 mm

- 24" handrim for 24" wheel and 25" wheel A9000205010-004
- 26" handrim for 26" wheel A9000205010-006



## Aluminum Ø 19 mm silver anodised

- 24" handrim for 24" wheel and 25" wheel A9000205019-004



## Aluminum Ø 19 mm powder coated in frame colour

(basic colour with two-colour design)

- = Gloss surface
- = Matt surface

Note: Matt coating is not recommended due to the low grip.

- 24" handrim for 24" wheel and 25" wheel A9000205020-004 € 66.30
- 26" handrim for 26" wheel A9000205020-006 € 66.30



## Aluminum Ø 19 mm polished and hard-anodised

- 24" handrim for 24" wheel and 25" wheel A9000205030-004 € 160.10
- 26" handrim for 26" wheel A9000205030-006 € 160.10

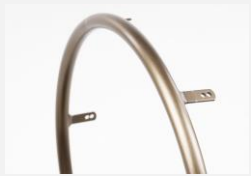

## Titanium Ø 19 mm

- 24" handrim for 24" wheel and 25" wheel A9000205040-004 € 325.80
- 26" handrim for 26" wheel A9000205040-006 € 325.80



## Silicone handrim cover

- for 24" handrim A9000205100-004 € 226.00
  - for 26" handrim A9000205100-006 € 226.00
- Surface without structure, compatible with handrim Ø 19 mm or Ø 20 mm.

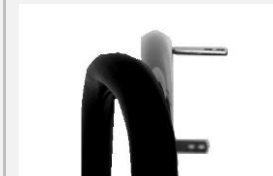

## Ultra-Grip „very grippy“

- 24" handrim for 24" wheel and 25" wheel A9000205070-004 € 390.70
- 26" handrim for 26" wheel A9000205070-006 € 390.70



## Ergo-Grip

- 24" handrim for 24" wheel and 25" wheel A9000205080-004 € 396.80
  - 26" handrim for 26" wheel A9000205080-006 € 396.80
- Attachment fitting to the rim



## Curve black anodised, ergonomic handrim profile

- 24" handrim for 24" wheel and 25" wheel H 24 mm A9000205130-004 € 389.10
- 24" handrim for 24" wheel and 25" wheel H 31 mm, size L A9000205140-004 € 389.10
- 26" handrim for 26" wheel H 31 mm, size L A9000205140-006 € 389.10



<p><b>Curve silver anodised ergonomic handrim profile</b></p> <p><input type="checkbox"/> 24" handrim for 24" wheel and 25" wheel H 31 mm, size L A9000205160-004 <b>€ 394.30</b></p> 	<p><b>Curve powder-coated, ergonomic handrim profile</b></p> <p><input type="checkbox"/> = Frame colour (gloss surface) <input type="checkbox"/> = Black (gloss surface)</p> <p><input type="checkbox"/> 24" handrim for 24" wheel and 25" wheel H 24 mm A9000205135-004 <b>€ 454.00</b></p> <p><input type="checkbox"/> 24" handrim for 24" wheel and 25" wheel H 31 mm, size L A9000205145-004 <b>€ 454.00</b></p> <p><input type="checkbox"/> 26" handrim for 26" wheel H 31 mm, size L A9000205145-006 <b>€ 454.00</b></p> 	<p><b>Curve Grip, with Tetra-Grip coating, ergonomic handrim profile</b></p> <p><input type="checkbox"/> 24" handrim for 24" wheel and 25" wheel H 31 mm, size L A9000205150-004 <b>€ 505.50</b></p> 
<p><b>Quadro with Tetra-Grip coating</b></p> <p><input type="checkbox"/> 24" handrim for 24" wheel and 25" wheel A9000205170-004 <b>€ 517.50</b></p> <p><input type="checkbox"/> 25" handrim for 25" wheel A9000205170-005 <b>€ 517.50</b></p> <p><input type="checkbox"/> 26" handrim for 26" wheel A9000205170-006 <b>€ 517.50</b></p> 	<p><b>Gekko black anodised</b></p> <p><input type="checkbox"/> 24" handrim for 24" wheel and 25" wheel A9000205175-004 <b>€ 501.20</b></p> <p><input type="checkbox"/> 25" handrim for 25" wheel A9000205175-005 <b>€ 501.20</b></p> <p><input type="checkbox"/> 26" handrim for 26" wheel A9000205175-006 <b>€ 501.20</b> with a robust and replaceable silicone lip, fully integrated into the profile</p> 	<p><b>Gekko silver anodised</b></p> <p><input type="checkbox"/> 24" handrim for 24" wheel and 25" wheel A9000205185-004 <b>€ 513.20</b> with a robust and replaceable silicone lip, fully integrated into the profile</p> 
<p><b>Gekko S black anodised</b></p> <p><input type="checkbox"/> 24" handrim for 24" wheel and 25" wheel A9000205195-004 <b>€ 501.20</b> with a robust and replaceable silicone lip, fully integrated into the profile Profile height 24 mm</p> 	<p><b>Equipment without handrims</b></p> <p><input checked="" type="checkbox"/> A9000205990</p>	

## Spoke guard

### Finger- and spoke guard "transparent"

for 24" wheel  
A9000206300-004 € 201.10

for 26" wheel  
A9000206300-006 € 201.10

Not in combination with Spinergy drive wheels.



## Tyres

If not specified, the "Schwalbe RightRun in black" tyres will be delivered.

### Schwalbe „RightRun“ High-pressure tyre

24x1" (540-25)  
A9000204001-004

Colour: Black  
7.5 bar



### Schwalbe „RightRun“ High-pressure tyre

24x1" (540-25)  
A9000204000-004

25x1" (559-25)  
A9000204000-005

26x1" (590-25)  
A9000204000-006

Colour: Grey, black wall  
7.5 bar



### Schwalbe „DownTown“ Profiled tyres

24x1" (540-25)  
A9000204010-004

7.5 bar



### Schwalbe „Marathon Plus Evolution“ with "smart guard" puncture protection

24x1" (540-25)  
A9000204030-014 € 47.80

25x1" (559-25)  
A9000204030-015 € 47.80

26x1" (590-25)  
A9000204030-016 € 47.80

Colour: Black  
10 bar



### Schwalbe „Marathon Plus“ with "smart guard" puncture protection

24x1" (540-25)  
A9000204030-004 € 47.80

Colour: Grey, black wall  
10 bar



### Schwalbe „One“

24x1" (540-25)  
A9000204123-004 € 90.30

Colour: Black  
9 bar



### Puncture-proof "solid rubber tyres"

24x1" (540-25)  
A9000204201-004 € 119.10

Colour: Black

Not in combination with Spinergy drive wheels.





## Accessories

### 24" MTB spare wheel set

with double rim (ETRTO 507), aluminum front hub, quick-release axle and stainless steel handrim  
Mountain bike tyres, selectively:

A9000203410 € 682.90

24x1.75" Schwalbe "Marathon Plus"  
Brake setting compatible with 24x1" wheel



A9000203413 € 682.90

24x2.1" Schwalbe "SMART SAM Sport"  
Brake setting not compatible with 24x1" wheel



NOTE: We charge a surcharge for the use of drum brakes

A9000200004 € 221.10

### Through axle with assistance, Large push button

A9000200096 € 102.70

Interlock dimension: 122 / 110 mm  
Axle diameter: 12 mm  
Not in conjunction with lockable drive wheel axle clip "Tetra Clip",  
not in combination with one-hand drive



### Lockable drive wheel axle clip "Tetra Clip"

A9000206400 € 161.60

Not in combination with Spinerger drive wheels,  
one-hand drive, drum brake or Liteline hub



### Hand air compressor with pressure gauge

A9000901100 € 103.20

up to 14 bar



### Length-adjustable safety belt with buckle

A9000902100 € 78.30



### Adjustable safety belt with hook and fastener

A9000902110 € 62.60



### Crutch holder with flexible nylon cup

A9000902310\* € 133.40

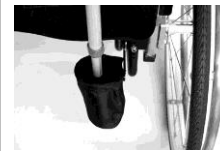

### SIGMA lighting set

A9000903270 € 104.80

Consisting of front light and rear lights,  
chargeable via Micro USB socket,  
incl. Micro USB charging cable  
Lighting set compliant with road traffic regulations



### Transport bag for drive wheels

for 24" wheel  
A9000903530-004 € 75.50  
Ø 76 cm x 2 cm

for 26" wheel  
A9000903530-006 € 75.50  
Ø 83 cm x 2 cm



Further accessories (such as handbikes, steering attachments, etc.) see separate order form or [www.proactiv-gmbh.de](http://www.proactiv-gmbh.de).

Notes and remarks:

---

**Location, Date**

**Signature End customer/dealer**

The signature field is intended for the consultant and insured person. This confirms that the intended equipment is intended for the insured person.

- 18 - 2024-06-01 / The prices are plus statutory value-added tax and shipping costs  = Included in the basic price  = Position selected  
Order sheet SPEEDY A1 Rev. 07 UK