



Quotation date: _____
Consultation was carried out by
Staff at the medical supplies shop: _____

Order date: _____
according to GTC PRO ACTIV Reha-Technik GmbH

Medical suppliers / company address:

Cust. no.: _____
Name: _____
Street: _____
Postcode / city: _____
Phone: _____
Fax: _____
E-Mail: _____
Contact: _____

Shipping address: **same as company address**
 Other (see below)

Name: _____
Street: _____
Postcode / city: _____

Customer name / commission:

Surname, forename: _____
Street: _____
Postcode / city: _____
Phone: _____
Fax: _____
E-Mail: _____
D.O.B: _____
Paying organisation: _____

LITTY 4you
Wheelchair for children

Maximum user weight limit 50 kg
Weight from 6.7 kg

A9042100000 € 4,560.00

Invoicing address: **same as company address**
 other (see below)

Cust. no.: _____
Name: _____
Street: _____
Postcode / city: _____
Phone: _____
Fax: _____
E-Mail: _____
Contact: _____

Body size:

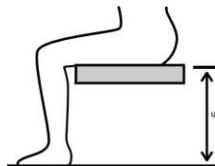

Body height: _____ cm
Weight: _____ cm
Lower leg length: _____ cm

(anatomic dimension: hollow of the knee to the foot sole)

Indication: _____

This information is necessary for checking. If the information is missing, a check of the relevant items cannot be made!

Basic size

Seat plate and back shell screwed to the side panel

Attention: Please select the seat plate and back shell separately

Wheelchair dimensions:

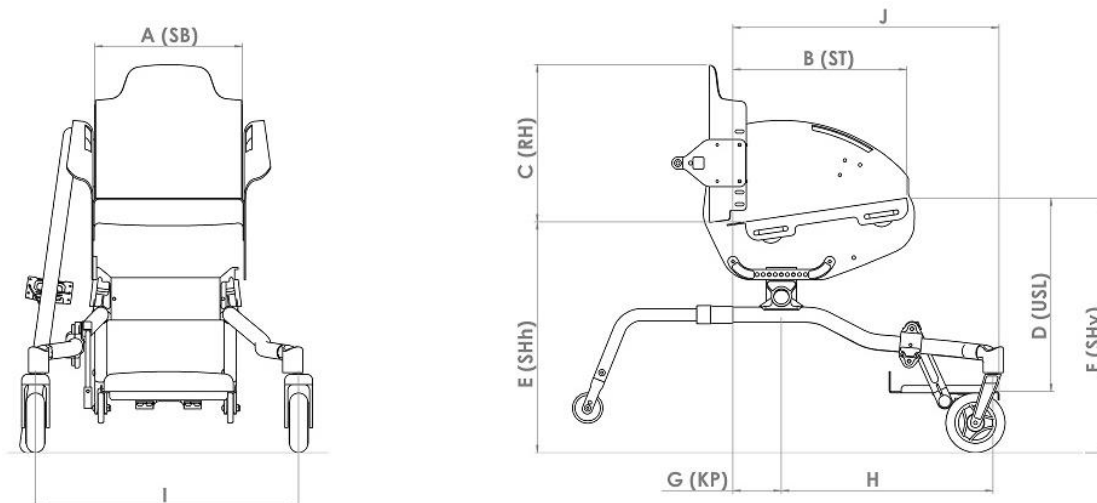

Seat width SB	<input type="checkbox"/> 16	<input type="checkbox"/> 17	<input type="checkbox"/> 18	<input type="checkbox"/> 19	<input type="checkbox"/> 20	<input type="checkbox"/> 21	<input type="checkbox"/> 22	<input type="checkbox"/> 23
	<input type="checkbox"/> 24	<input type="checkbox"/> 25	<input type="checkbox"/> 26	<input type="checkbox"/> 27	<input type="checkbox"/> 28	<input type="checkbox"/> 29	<input type="checkbox"/> 30	<input type="checkbox"/> 31
	<input type="checkbox"/> 32	<input type="checkbox"/> 33	<input type="checkbox"/> 34	<input type="checkbox"/> 35	<input type="checkbox"/> 36	<input type="checkbox"/> 37	<input type="checkbox"/> 38	

Seat depth ST	<input type="checkbox"/> 18	<input type="checkbox"/> 19	<input type="checkbox"/> 20	<input type="checkbox"/> 21	<input type="checkbox"/> 22	<input type="checkbox"/> 23	<input type="checkbox"/> 24	<input type="checkbox"/> 25
	<input type="checkbox"/> 26	<input type="checkbox"/> 27	<input type="checkbox"/> 28	<input type="checkbox"/> 29	<input type="checkbox"/> 30	<input type="checkbox"/> 31	<input type="checkbox"/> 32	<input type="checkbox"/> 33
	<input type="checkbox"/> 34	<input type="checkbox"/> 35	<input type="checkbox"/> 36	<input type="checkbox"/> 37	<input type="checkbox"/> 38			

Back height RH	<input type="checkbox"/> 20	<input type="checkbox"/> 21	<input type="checkbox"/> 22	<input type="checkbox"/> 23	<input type="checkbox"/> 24	<input type="checkbox"/> 25	<input type="checkbox"/> 26	<input type="checkbox"/> 27	<input type="checkbox"/> 28	<input type="checkbox"/> 29
	<input type="checkbox"/> 30	<input type="checkbox"/> 31	<input type="checkbox"/> 32	<input type="checkbox"/> 33	<input type="checkbox"/> 34	<input type="checkbox"/> 35	<input type="checkbox"/> 36	<input type="checkbox"/> 37	<input type="checkbox"/> 38	<input type="checkbox"/> 39
	<input type="checkbox"/> 40	<input type="checkbox"/> 41	<input type="checkbox"/> 42	<input type="checkbox"/> 43	<input type="checkbox"/> 44	<input type="checkbox"/> 45				

Lower leg length USL	<input type="checkbox"/> 20	<input type="checkbox"/> 21	<input type="checkbox"/> 22	<input type="checkbox"/> 23	<input type="checkbox"/> 24	<input type="checkbox"/> 25	<input type="checkbox"/> 26	<input type="checkbox"/> 27	<input type="checkbox"/> 28	<input type="checkbox"/> 29
	<input type="checkbox"/> 30	<input type="checkbox"/> 31	<input type="checkbox"/> 32	<input type="checkbox"/> 33	<input type="checkbox"/> 34	<input type="checkbox"/> 35	<input type="checkbox"/> 36	<input type="checkbox"/> 37	<input type="checkbox"/> 38	<input type="checkbox"/> 39
	<input type="checkbox"/> 40	<input type="checkbox"/> 41	<input type="checkbox"/> 42	<input type="checkbox"/> 43	<input type="checkbox"/> 44	<input type="checkbox"/> 45				

Seat height back SHh	<input type="checkbox"/> 31	<input type="checkbox"/> 32	<input type="checkbox"/> 33	<input type="checkbox"/> 34	<input type="checkbox"/> 35	<input type="checkbox"/> 36
	<input type="checkbox"/> 37	<input type="checkbox"/> 38	<input type="checkbox"/> 39	<input type="checkbox"/> 40	<input type="checkbox"/> 41	<input type="checkbox"/> 42

Seat height front SHh	<input type="checkbox"/> 34	<input type="checkbox"/> 35	<input type="checkbox"/> 36	<input type="checkbox"/> 37	<input type="checkbox"/> 38	<input type="checkbox"/> 39	<input type="checkbox"/> 40
	<input type="checkbox"/> 41	<input type="checkbox"/> 42	<input type="checkbox"/> 43	<input type="checkbox"/> 44	<input type="checkbox"/> 45	<input type="checkbox"/> 46	<input type="checkbox"/> 47

Tipping point **KP**
(front side rear tube to axis middle drive wheel) _____ cm (if not specified, a default value of 8 cm will be set)

H: Position of the steering wheel bearing block _____ cm (if not specified: 20" and 22" = 35 cm or 24" = 38 cm)

I: Distance between steering wheel bearing blocks _____ cm (if not specified: seat width + 19 cm)

J: Distance front edge footrest to rear _____ cm (if not specified: seat depth + 15 cm)

Deviating dimensions are possible subject to surcharge

Dimensional tolerances according to DIN EN ISO 13920 apply for the design

Degree of accuracy	Up to 30	More then 30 to 120	More then 120 to 400	More then 400 to 1000
C	+/- 1	+/- 3	+/- 4	+/- 6

Frame colour - one-colour design

Frame, side parts and seat system

Information on current colour designs and example images at: www.proactiv-gmbh.de/farben.php

Frame colour: Selection from colour palette

Frame colour will be specified with order

A9000100170-000

Raw, blasted, not coated

A9000100170-020

Note: In combination with moisture e.g. hand perspiration, can affect dark aluminum discoloration.

Powder colours

White RAL 9016

gloss A9000100170-023

matt A9000100170-123 € 42.10

Brilliant silver

gloss A9000100170-011

Anthracite RAL 7016

gloss A9000100170-001

matt A9000100170-101 € 42.10

Black RAL 9005

gloss A9000100170-003

matt A9000100170-019 € 42.10

Pure orange RAL 2004

gloss A9000100170-022

matt A9000100170-122 € 42.10

Pink magenta RAL 4010

gloss A9000100170-037

matt A9000100170-137 € 42.10

Pastel blue RAL 5024

gloss A9000100170-036

matt A9000100170-136 € 42.10

Lemon green

gloss A9000100170-005

matt A9000100170-105 € 42.10

Yellow RAL 1023

gloss A9000100170-046

matt A9000100170-146 € 42.10

Red RAL 3001

gloss A9000100170-047

matt A9000100170-147 € 42.10

Lagoon blue

gloss A9000100170-052

matt A9000100170-152 € 42.10

Athletic grey

gloss A9000100170-050

matt A9000100170-150 € 42.10

Muddy grey

gloss A9000100170-051

matt A9000100170-151 € 42.10

Powder colours „Dormant“

Deep black effect silver

gloss A9000100170-007

Sky blue

gloss A9000100170-017

Navy blue

gloss A9000100170-045

matt A9000100170-145 € 42.10

Electric green

gloss A9000100170-015

matt A9000100170-115 € 42.10

Violet

gloss A9000100170-044

Fire red

gloss A9000100170-018

matt A9000100170-118 € 42.10

Frame colour - One-colour design special colours “liquid coating”

Frame, side parts and seat system

€ 339.40

Storm (ice blue)

gloss A9000100170-500

matt A9000100170-501

Coffee

gloss A9000100170-520

matt A9000100170-521

Prairie (rose gold)

gloss A9000100170-504

matt A9000100170-505

Pearl (mother of pearl-white)

gloss A9000100170-524

matt A9000100170-525

Berry

gloss A9000100170-526

matt A9000100170-527

Blue ocean

gloss A9000100170-522

matt A9000100170-523

Emerald

gloss A9000100170-514

matt A9000100170-515

Mint

gloss A9000100170-528

matt A9000100170-529

Chili

gloss A9000100170-516

matt A9000100170-517

Frame colour - Two-colour design

Note: In the two-colour design, both colours are the same gloss level as the design colour.

- Two-colour design consisting of one frame colour and a second colour for the side parts or seat plate and back shell** € 260.70
A9042100170-200

Please select the colours below:

Two-colour design Litty consisting of a base colour at the frame with axle tube and a second colour for the side parts and, if desired, for the seat system. Select from one-colour design:

A: Frame colour: A9000100170-

B: Side part colour: A9000100170-

Colour seat plate and back shell: A oder B

Colour - Attachment parts

Note: If not specified, the caster fork and bearing block will be mounted in black.

Drive wheel: aluminum rim, hub and spokes

- Black A9000100171-003

Caster fork and bearing block

- Silver A9000100173-011
 Black A9000100173-003

Colour design of attachment parts according to customer request:

Drive wheel: Aluminium rim and design inlet¹

- Frame colour A9000100171-999 € 242.30
 Select from one-colour design (different from the frame color) A9000100171-998 € 280.50
Colour: _____
A9000100170-

Caster wheel: 5" aluminium rim² (3-spoke design)

- Frame colour A9000100174-999 € 73.00
 Select from one-colour design (different from the frame color) A9000100174-998 € 84.60
Colour: _____
A9000100170-

Special colour requests (frame or attachment parts)

Frame colour for single purchasing Selection from RAL colour palette

- A9000100170-100 € 402.30

Gloss level

- gloss
 matt

colour name

RAL number

Note: attachment parts are **not** possible in design colors

¹ Only in conjunction with Litaline hub (for drive wheel aluminum rim with 18 spokes)

² Only in conjunction with caster wheel 5" aluminum rim 3-spoke design good shock absorption A9000501210 or A9000501211

Push handles

Central push handle aluminum

A9042401085-K
height-adjustable
Holder welded to the center of the back crossbar



Central push handle aluminum with foldable handle area

A9042401084-K € 99.60
height-adjustable and foldable in the handle area via toothed joint
Holder welded in the middle of the back crossbar
Approved up to a body weight of 50 kg



Central push handle aluminum for brake handles with foldable handle area

A9042401086-K € 137.80
height-adjustable and foldable in the handle area via toothed joint
Holder welded in the middle of the back crossbar
Approved up to a body weight of 50 kg
Only in conjunction with A9042701020 Parking knee lever brake for accompanying person



Safety push handles back-positioned

Length: 45 cm
max. height = SHh + approx. 53 cm
A9042401075-K001

Length: 55 cm
max. height = SHh + approx. 63 cm
A9042401075-K002

continuous height adjustment,
Safety push handle holder mounted on the back cross bar



Aluminum push handle closed, can be folded down via toothed joint

A9042401069-K € 378.50
continuous height adjustment,
Push handle holder shifted back



Equipment without push handles

A9000401000



Back equipment

If not specified, the "Ergonomic back shell" will be delivered.

Ergonomic back shell aluminum

A9042802210-K € 428.70
in frame colour
from RH 20 cm and SB 16 cm



Back cushion for ergonomic back shell

A9042802220-K € 211.90

Cover:
 Black, breathable, open surface
 Black, breathable, closed surface

If no specification is made, the cover material "Black, breathable, open surface" will be delivered.



Equipment without back shell and back cushion

A9042802011

Seat system

Seat plate aluminum

A9042801210-K
in frame colour
bolted between the aluminum side parts
adjustable in height, angle and depth



Seat cushion

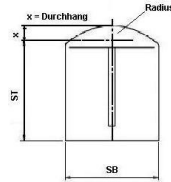
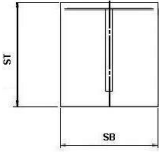

Seat cushion in rectangular contour Inlet: Standard

A9000805180-K* € 111.90

Seat cushion with radius contour Inlet: Standard

A9000800300-K* € 155.40

Seat cushion height:

3 cm 5 cm
 4 cm 6 cm

Seat cushion in rectangular contour Inlet: Anti-Decubitus

up to 30x30 cm
A9000805204-K* € 290.00

>30x30 up to 50x50 cm
A9000805200-K* € 422.00

Seat cushion with radius contour Inlet: Anti-Decubitus

up to 30x30 cm
A9000800311-K* € 342.80

>30x30 up to 50x50 cm
A9000800310-K* € 465.90

Seat cushion height:

4 cm
 6 cm

Cover:

Black, breathable, open surface

Black, breathable, closed surface

If no specification is made, the cover material "Black, breathable, open surface" will be delivered.

Seat cushion is existing

You can also find the seat cushions on our separate order sheet: "PRO ACTIV seat and backrest systems"

Wheel camber

6° drive wheel camber

A9042202010

8° drive wheel camber

A9042202020

9,5° drive wheel camber

A9042202060

11° drive wheel camber

A9042202030

13° drive wheel camber

A9042202040

15° drive wheel camber

A9042202050

E-Adaptations

Preparation for "e-motion" mounting

A9042201200-K € 488.30

Equipment: e-motion torque support,
1/2" axle and socket length 50.8 mm (2")
Up to 40 kg: 9.5° camber, over 40 kg: 6° and 8°
camber

Only in conjunction with 22" or 24" drive wheels
and mounting of anti-tipping supports in pairs.
Please choose "Adaptations" under the
selection.



Brake system

If not specified, the "Brake system push to lock" will be delivered.

Brake system push to lock

- A9042701010
Brake lever integrated in side part



Parking knee lever brake for accompanying person

- A9042701020 € 450.60
Push handle operation via Bowden cable.
Only in combination with knee lever brake and push handles



Footrest

If not specified, the "fixed footrest" will be delivered.

Fixed footrest

- A9042601010-K
adjustable in height, depth and angle
incl. footrest covered with anti-slip foil



Foot support folds up to the rear

- A9042602010-K € 278.40
incl. footrest covered with anti-slip foil



Adaptations

Anti-tipping support - pivots upwards

- right side A9042301160-12* € 201.10
 left side A9042301160-22* € 201.10
removable with quickpin



Outdoor wheel attachment with steering fork

- A9042900200-K € 821.10
Equipped with straight-running lock
can be removed from the wheelchair via quick
release lever with swivelling pneumatic tyre
12.1/2 x 2.1/4" caster wheel
can be removed from the support tube via
quick-release axle
for maximum ground pressure at the
steering attachment of 30 kg



Outdoor wheel attachment, rigid without steering function

- A9042900100-K € 730.60
suitable for pushing by an accompanying
person,
with pneumatic tyre 12.1/2 x 2.1/4" caster
wheel for maximum ground pressure at the
steering attachment of 30 kg



3" caster wheel

3" safety light-up wheel (80 mm)

- A9000501110 € 68.70
puncture-proof



4" caster wheel

4" caster wheel „Standard“ solid rubber black

A9000501011-004
(82A), puncture-proof



4" Skate wheel (100 mm)

A9000501120
puncture-proof

€ 68.70



4" safety light-up wheel (100 mm)

A9000501220
puncture-proof

€ 92.00



4" Frog Legs caster wheel (100 mm)

A9000501230 € 206.30
with replaceable rubber 6 mm, puncture-proof
Colour: black, silver rim
Incl. hair guard spacer (5.3 mm)



5" caster wheel

5" caster wheel „Standard“ PU black

A9000501036-005
(82A), puncture-proof



5" caster wheel „Standard“ PU grey

A9000501031-005
(82A), puncture-proof



5" safety light-up wheel (125 mm)

A9000501221
puncture-proof

€ 92.00



5" aluminum rim 3-spoke design “good shock absorption”

Silver
A9000501210 € 174.60

Black
A9000501211 € 174.60

with replaceable rubber 6 mm medium hard,
puncture-proof
Incl. hair guard spacer (3 mm)



5" Frog Legs caster wheel (125 mm)

A9000501232 € 206.30
with replaceable rubber 6 mm, puncture-proof
Colour: black, silver rim
Incl. hair guard spacer (5.3 mm)



Caster fork

If not specified, the "standard caster fork with screw axle" will be delivered.

Caster fork Standard

- A9000500100-K001
with screwed axle
- A9000500100-K002 € 162.50
with quick-release axle



Caster fork short

- A9000500110-K001
with screwed axle
- A9000500110-K002 € 162.50
with quick-release axle
Not in combination with 5" caster wheels



Caster fork spare wheel LITTY

- A9000500300-K € 288.10
with quick-release axle

The article will be delivered without steering wheels.
If caster wheels are required, please select a second option under the category "Caster wheels".



Drive wheels

Drive wheel aluminum rim, 18 spokes with Liteline hub

radially spoked
Design inlet in frame color



- 20" (ETRTO 451)
A9000203053
- 22" (ETRTO 489)
A9000203063
- 24" (ETRTO 540)
A9000203123

Handrims

x = dimension handrim attachment

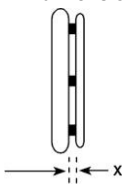

Handrim attachment
general:

- x = 11 mm
 x = 19 mm

Handrim attachment
Curve + Gekko handrim:

- x = 10 mm
 x = 18 mm

If not specified, the handrim will be mounted narrow (11 mm / 10 mm).

Stainless steel Ø 20 mm

- 20" handrim for
20" wheel
A9000205010-001
- 22" handrim for
22" wheel
A9000205010-002
- 24" handrim for
24" wheel
A9000205010-004



Aluminum Ø 19 mm silver anodised

- 24" handrim for
24" wheel
A9000205019-004



Aluminum Ø 16 mm powder coated in frame colour

(basic colour with two-colour design)

- = Gloss surface
 = Matt surface

Note: Matt coating is not recommended due to the low grip.

- 20" handrim for
20" wheel € 66.30
A9000205021-001
- 22" handrim for
22" wheel € 66.30
A9000205021-002









<p>Aluminum Ø 19 mm powder coated in frame colour (basic colour with two-colour design)</p> <p><input type="checkbox"/> = Gloss surface <input type="checkbox"/> = Matt surface</p> <p>Note: Matt coating is not recommended due to the low grip.</p> <p><input type="checkbox"/> 20" handrim for 20" wheel € 66.30 A9000205020-001</p> <p><input type="checkbox"/> 22" handrim for 22" wheel € 66.30 A9000205020-002</p> <p><input type="checkbox"/> 24" handrim for 24" wheel € 66.30 9000205020-004</p> 	<p>Aluminum ø 16 mm polished and hard-anodised</p> <p><input type="checkbox"/> 20" handrim for 20" wheel € 160.10 A9000205031-001</p> <p><input type="checkbox"/> 22" handrim for 22" wheel € 160.10 A9000205031-002</p> 	<p>Aluminum ø 19 mm polished and hard-anodised</p> <p><input type="checkbox"/> 20" handrim for 20" wheel € 160.10 A9000205030-001</p> <p><input type="checkbox"/> 22" handrim for 22" wheel € 160.10 A9000205030-002</p> <p><input type="checkbox"/> 24" handrim for 24" wheel € 160.10 A9000205030-004</p> 
<p>Titan ø 19 mm</p> <p><input type="checkbox"/> 24" handrim for 24" wheel € 325.80 A9000205040-004</p> 	<p>Silicone handrim cover</p> <p><input type="checkbox"/> for 20" handrim € 226.00 A9000205100-001</p> <p><input type="checkbox"/> for 22" handrim € 226.00 A9000205100-002</p> <p><input type="checkbox"/> for 24" handrim € 226.00 A9000205100-004</p> <p>Surface without structure, compatible with handrim Ø 19 mm or Ø 20 mm.</p> 	<p>Ultra-Grip „very grippy“</p> <p><input type="checkbox"/> 20" handrim for 20" wheel € 390.70 A9000205070-001</p> <p><input type="checkbox"/> 22" handrim for 22" wheel € 390.70 A9000205070-002</p> <p><input type="checkbox"/> 24" handrim for 24" wheel € 390.70 A9000205070-004</p> 
<p>Ergo-Grip</p> <p><input type="checkbox"/> 20" handrim for 20" wheel € 396.80 A9000205080-001</p> <p><input type="checkbox"/> 22" handrim for 22" wheel € 396.80 A9000205080-002</p> <p><input type="checkbox"/> 24" handrim for 24" wheel € 396.80 A9000205080-004</p> <p>Attachment fitting to the rim</p> 	<p>Maxgrepp with cell and natural rubber cover very good grip, soft</p> <p><input type="checkbox"/> 20" handrim for 20" wheel € 396.80 A9000200788</p> <p><input type="checkbox"/> 22" handrim for 22" wheel € 396.80 A9000200789</p> <p><input type="checkbox"/> 24" handrim for 24" wheel € 396.80 A9000200787</p> 	<p>Curve black anodised, ergonomic handrim profile</p> <p><input type="checkbox"/> 24" handrim for 24" wheel € 389.10 H 24 mm A9000205130-004</p> <p><input type="checkbox"/> 24" handrim for 24" wheel € 389.10 H 31 mm, size L A9000205140-004</p> 

<p>Curve powder-coated, ergonomic handrim profile</p> <p><input type="checkbox"/> = Frame colour (gloss surface) <input type="checkbox"/> = Black (gloss surface)</p> <p><input type="checkbox"/> 24" handrim for 24" wheel H 24 mm A9000205135-004 € 454.00</p> 	<p>Curve Grip, with Tetra-Grip coating, ergonomic handrim profile</p> <p><input type="checkbox"/> 24" handrim for 24" wheel H 24 mm A9000205155-004 € 505.50</p> 	<p>Quadro with Tetra-Grip coating</p> <p><input type="checkbox"/> 24" handrim for 24" wheel A9000205170-004 € 517.50</p> 	
<p>Gekko black anodised</p> <p><input type="checkbox"/> 24" handrim for 24" wheel A9000205175-004 with a robust and replaceable silicone lip, fully integrated into the profile Profile height 31 mm € 501.20</p> 	<p>Gekko silver anodised</p> <p><input type="checkbox"/> 24" handrim for 24" wheel A9000205185-004 with a robust and replaceable silicone lip, fully integrated into the profile Profile height 31 mm € 513.20</p> 	<p>Gekko S black anodised</p> <p><input type="checkbox"/> 22" handrim for 22" wheel A9000205195-002 € 501,20</p> <p><input type="checkbox"/> 24" handrim for 24" wheel A9000205195-004 with a robust and replaceable silicone lip, fully integrated into the profile Profile height 24 mm € 501.20</p> 	
<p>Equipment without handrims</p> <p><input type="checkbox"/> A9000205990</p>			
<p>Spoke guard</p>			
<p>Finger- and spoke guard "transparent"</p>			
<p><input type="checkbox"/> for 20" wheel A9000206300-001 € 201.10</p>	<p><input type="checkbox"/> for 22" wheel A9000206300-002 € 201.10</p>	<p><input type="checkbox"/> for 24" wheel A9000206300-004 € 201.10</p> 	
<p>Tyres</p> <p>If not specified, the "Schwalbe RightRun in black" tyres will be delivered.</p>			
<p>Schwalbe „RightRun“ High-pressure tyres</p> <p><input type="checkbox"/> 22x1" (489-25) A9000204001-002</p> <p><input type="checkbox"/> 24x1" (540-25) A9000204001-004</p> <p>Colour: Black 7.5 bar</p> 	<p>Schwalbe „RightRun“ High-pressure tyres</p> <p><input type="checkbox"/> 20x1" (451-25) A9000204000-001</p> <p><input type="checkbox"/> 22x1" (489-25) A9000204000-002</p> <p><input type="checkbox"/> 24x1" (540-25) A9000204000-004</p> <p>Colour: Grey, black wall 7.5 bar</p> 	<p>Schwalbe "MarathonPlus Evolution" with "smart guard" puncture protection and reflector strips</p> <p><input type="checkbox"/> 22x1" (489-25) A9000204030-002 € 47.80</p> <p>Colour: Black 10 bar</p> 	

<p>Schwalbe „Marathon Plus Evolution“ with “smart guard” puncture protection</p> <p><input type="checkbox"/> 24x1" (540-25) A9000204030-014 € 47.80</p> <p>Colour: Black 10 bar</p> 	<p>Schwalbe „Marathon Plus“ with “smart guard” puncture protection</p> <p><input type="checkbox"/> 24x1" (540-25) A9000204030-004 € 47.80</p> <p>Colour: Grey, black wall 10 bar</p> 	
---	---	--

Accessories

<p>Through axle with assistance, Large push button</p> <p><input type="checkbox"/> A9000200096 € 102.70</p> <p>Interlock dimension: 122 / 110 mm Axle diameter: 12 mm Not in conjunction with lockable drive wheel axle clip “Tetra Clip”</p> 	<p>Hand air compressor with pressure gauge</p> <p><input type="checkbox"/> A9000901100 € 103.20</p> <p>up to 14 bar</p> 	<p>Length-adjustable safety belt with buckle</p> <p><input type="checkbox"/> A9000902100 € 78.30</p> 
<p>Adjustable safety belt with hook and fastener</p> <p><input type="checkbox"/> A9000902110 € 62.60</p> 	<p>Transport bag for drive wheels</p> <p><input type="checkbox"/> for 24" wheel A9000903530-004 € 75.50</p> <p>Ø 76 cm x 2 cm</p> 	<p>Therapy table</p> <p><input type="checkbox"/> Width 350 mm A9000902800-001 € 466.20</p> <p>removable table top made of Lexan, transparent, with front edging, with 2 positioning stops Ø 25 mm (for adaptation to frame tube Ø 25 mm)</p> 

Further accessories (such as handbikes, steering attachments, etc.) see separate order form or www.proactiv-gmbh.de.

Notes and remarks:

Location, Date

Signature End customer/dealer

The signature field is intended for the consultant and insured person. This confirms that the intended equipment is intended for the insured person.

- 12 - 2024-06-01 / The prices are plus statutory value-added tax and shipping costs = Included in the basic price = Position selected
Order sheet LITTY 4you Rev. 05 UK