



**Quotation date:** \_\_\_\_\_  
**Consultation was carried out by**  
**Staff at the medical supplies shop:** \_\_\_\_\_

**Order date:** \_\_\_\_\_  
according to GTC PRO ACTIV Reha-Technik GmbH

**Medical suppliers / company address:**

Cust. no.: \_\_\_\_\_  
Name: \_\_\_\_\_  
Street: \_\_\_\_\_  
Postcode / city: \_\_\_\_\_  
Phone: \_\_\_\_\_  
Fax: \_\_\_\_\_  
E-Mail: \_\_\_\_\_  
Contact: \_\_\_\_\_

**Shipping address:**  **same as company address**  
 **Other (see below)**

Name: \_\_\_\_\_  
Street: \_\_\_\_\_  
Postcode / city: \_\_\_\_\_

**Customer name / commission:**

Surname, forename: \_\_\_\_\_  
Street: \_\_\_\_\_  
Postcode / city: \_\_\_\_\_  
Phone: \_\_\_\_\_  
Fax: \_\_\_\_\_  
E-Mail: \_\_\_\_\_  
D.O.B: \_\_\_\_\_  
Paying organisation: \_\_\_\_\_

## LIFT solid with mechanical seat height adjustment

The desired work height is set by means of the user-friendly, manual and continuous adjustment of the seat height, with the help of gas pressure springs. With just a little muscle power, the seat lifts up to 30 cm.

Maximum user weight limit 120 kg

A9060100000\* € 7,860.00

**Invoicing address:**  **same as company address**  
 **other (see below)**

Cust. no.: \_\_\_\_\_  
Name: \_\_\_\_\_  
Street: \_\_\_\_\_  
Postcode / city: \_\_\_\_\_  
Phone: \_\_\_\_\_  
Fax: \_\_\_\_\_  
E-Mail: \_\_\_\_\_  
Contact: \_\_\_\_\_

# Basic size

## Body size:

Body height: \_\_\_\_\_ cm

Weight: \_\_\_\_\_ cm

Lower leg length: \_\_\_\_\_ cm

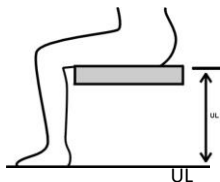

(anatomic dimension: hollow of the knee to the foot sole)

Indication: \_\_\_\_\_

This information is necessary for checking. If the information is missing, a check of the relevant items cannot be made!

## Wheelchair dimensions:

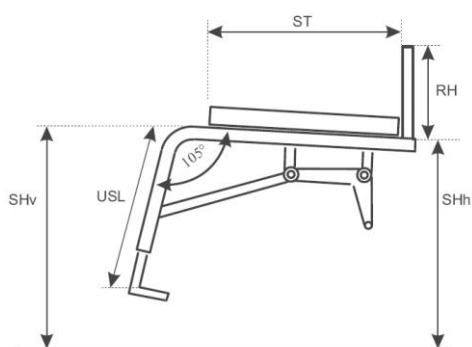

<b>Seat width SB</b>	<input type="checkbox"/> 35	<input type="checkbox"/> 36	<input type="checkbox"/> 37	<input type="checkbox"/> 38	<input type="checkbox"/> 39	<input type="checkbox"/> 40					
	<input type="checkbox"/> 41	<input type="checkbox"/> 42	<input type="checkbox"/> 43	<input type="checkbox"/> 44	<input type="checkbox"/> 45	<input type="checkbox"/> 46					
	The following dimensions are optionally available subject to surcharge:						<input type="checkbox"/> 30	<input type="checkbox"/> 31	<input type="checkbox"/> 32	<input type="checkbox"/> 33	<input type="checkbox"/> 34
<b>Seat depth ST</b>	Frame size 1		Frame size 2			Frame size 3					
	<input type="checkbox"/> 35	<input type="checkbox"/> 36	<input type="checkbox"/> 39	<input type="checkbox"/> 40	<input type="checkbox"/> 41	<input type="checkbox"/> 44	<input type="checkbox"/> 45	<input type="checkbox"/> 46			
	<input type="checkbox"/> 37	<input type="checkbox"/> 38	<input type="checkbox"/> 42	<input type="checkbox"/> 43		<input type="checkbox"/> 47	<input type="checkbox"/> 48				
	The following dimensions are optionally available subject to surcharge:						<input type="checkbox"/> 25	<input type="checkbox"/> 26	<input type="checkbox"/> 27	<input type="checkbox"/> 28	<input type="checkbox"/> 29
<b>Back height RH</b>	<input type="checkbox"/> 20	<input type="checkbox"/> 21	<input type="checkbox"/> 22	<input type="checkbox"/> 23	<input type="checkbox"/> 24	<input type="checkbox"/> 25	<input type="checkbox"/> 26	<input type="checkbox"/> 27	<input type="checkbox"/> 28	<input type="checkbox"/> 29	
	<input type="checkbox"/> 30	<input type="checkbox"/> 31	<input type="checkbox"/> 32	<input type="checkbox"/> 33	<input type="checkbox"/> 34	<input type="checkbox"/> 35	<input type="checkbox"/> 36	<input type="checkbox"/> 37	<input type="checkbox"/> 38	<input type="checkbox"/> 39	
	<input type="checkbox"/> 40	<input type="checkbox"/> 41	<input type="checkbox"/> 42	<input type="checkbox"/> 43	<input type="checkbox"/> 44	<input type="checkbox"/> 45	<input type="checkbox"/> 46	<input type="checkbox"/> 47	<input type="checkbox"/> 48		
<b>Lower leg length USL</b>	<input type="checkbox"/> 30	<input type="checkbox"/> 31	<input type="checkbox"/> 32	<input type="checkbox"/> 33	<input type="checkbox"/> 34	<input type="checkbox"/> 35	<input type="checkbox"/> 36	<input type="checkbox"/> 37	<input type="checkbox"/> 38	<input type="checkbox"/> 39	<input type="checkbox"/> 40
	<input type="checkbox"/> 41	<input type="checkbox"/> 42	<input type="checkbox"/> 43	<input type="checkbox"/> 44	<input type="checkbox"/> 45	<input type="checkbox"/> 46	<input type="checkbox"/> 47	<input type="checkbox"/> 48	<input type="checkbox"/> 49	<input type="checkbox"/> 50	
	The following dimensions are optionally available subject to surcharge:						<input type="checkbox"/> 20	<input type="checkbox"/> 21	<input type="checkbox"/> 22	<input type="checkbox"/> 23	<input type="checkbox"/> 24
<b>Seat height back SHh</b>	<input type="checkbox"/> 42	<input type="checkbox"/> 45									
<b>Seat height front SHv</b>	for 4" caster wheel:	<input type="checkbox"/> 44	<input type="checkbox"/> 46	<input type="checkbox"/> 48	<input type="checkbox"/> 50						
	for 5" caster wheel:	<input type="checkbox"/> 46	<input type="checkbox"/> 48	<input type="checkbox"/> 50	<input type="checkbox"/> 52						
	for 6" caster wheel:	<input type="checkbox"/> 48	<input type="checkbox"/> 50	<input type="checkbox"/> 52	<input type="checkbox"/> 54						

Please select the required dimensions (all dimensions are in cm).

The underlined values are the standard settings.

The values SHh and SHv may deviate from the specified values depending on the wheel size and wheel camber!

## Frame colour - one-colour design

Information on current colour designs and example images at: [www.proactiv-gmbh.de/farben.php](http://www.proactiv-gmbh.de/farben.php)

### Frame colour: Selection from colour palette

Frame colour will be specified with order

A9000100170-000

Raw, blasted, not coated

A9000100170-020

Note: In combination with moisture e.g. hand perspiration, can affect dark aluminum discoloration.

### Powder colours

**White RAL 9016**

gloss A9000100170-023

matt A9000100170-123 € 42.10

**Brilliant silver**

gloss A9000100170-011

**Anthracite RAL 7016**

gloss A9000100170-001

matt A9000100170-101 € 42.10

**Black RAL 9005**

gloss A9000100170-003

matt A9000100170-019 € 42.10

**Pure orange RAL 2004**

gloss A9000100170-022

matt A9000100170-122 € 42.10

**Pink magenta RAL 4010**

gloss A9000100170-037

matt A9000100170-137 € 42.10

**Pastel blue RAL 5024**

gloss A9000100170-036

matt A9000100170-136 € 42.10

**Lemon green**

gloss A9000100170-005

matt A9000100170-105 € 42.10

**Yellow RAL 1023**

gloss A9000100170-046

matt A9000100170-146 € 42.10

**Red RAL 3001**

gloss A9000100170-047

matt A9000100170-147 € 42.10

**Lagoon blue**

gloss A9000100170-052

matt A9000100170-152 € 42.10

**Athletic grey**

gloss A9000100170-050

matt A9000100170-150 € 42.10

**Muddy grey**

gloss A9000100170-051

matt A9000100170-151 € 42.10

### Powder colours „Dormant“

**Deep black effect silver**

gloss A9000100170-007

**Sky blue**

gloss A9000100170-017

**Navy blue**

gloss A9000100170-045

matt A9000100170-145 € 42.10

**Electric green**

gloss A9000100170-015

matt A9000100170-115 € 42.10

**Violet**

gloss A9000100170-044

**Fire red**

gloss A9000100170-018

matt A9000100170-118 € 42.10

## Frame colour - One-colour design special colours “liquid coating”

€ 339.40

**Storm (ice blue)**

gloss A9000100170-500

matt A9000100170-501

**Coffee**

gloss A9000100170-520

matt A9000100170-521

**Prairie (rose gold)**

gloss A9000100170-504

matt A9000100170-505

**Pearl (mother of pearl-white)**

gloss A9000100170-524

matt A9000100170-525

**Berry**

gloss A9000100170-526

matt A9000100170-527

**Blue ocean**

gloss A9000100170-522

matt A9000100170-523

**Emerald**

gloss A9000100170-514

matt A9000100170-515

**Mint**

gloss A9000100170-528

matt A9000100170-529

**Chili**

gloss A9000100170-516

matt A9000100170-517

## Frame colour - Two-colour design

Note: In the two-colour design, both colours are the same gloss level as the design colour.

- Two-colour design with one base colour (on the rear frame) and one design colour (on the front frame)** € 260.70

Please select a color from below:

### Base colour (on the rear frame)

#### White RAL 9016

- A9000100170-200

#### Brilliant silver

- A9000100170-201

#### Anthracite RAL 7016

- A9000100170-202

#### Black RAL 9005

- A9000100170-203

#### Pastel blue RAL 5024

- A9000100170-206

#### Lemon green

- A9000100170-207

#### Yellow RAL 1023

- A9000100170-208

#### Lagoon blue

- A9000100170-212

#### Athletic grey

- A9000100170-210

#### Muddy grey

- A9000100170-211

### Design colour (on the front frame)

#### Black RAL 9005

- gloss A9000100170-259  
 matt A9000100170-260

#### Lemon green

- gloss A9000100170-250  
 matt A9000100170-251

#### Chili

- gloss A9000100170-253  
 matt A9000100170-254

#### Pure orange RAL 2004

- gloss A9000100170-255  
 matt A9000100170-256

#### Coffee

- gloss A9000100170-278  
 matt A9000100170-279

#### Mint

- gloss A9000100170-286  
 matt A9000100170-287

#### Emerald

- gloss A9000100170-274  
 matt A9000100170-275

#### Storm (ice blue)

- gloss A9000100170-264  
 matt A9000100170-265

#### Prairie (rose gold)

- gloss A9000100170-266  
 matt A9000100170-267

#### Pearl (mother of pearl-white)

- gloss A9000100170-282  
 matt A9000100170-283

#### Berry

- gloss A9000100170-284  
 matt A9000100170-285

#### Blue ocean

- gloss A9000100170-280  
 matt A9000100170-281

## Colour - Attachment parts

Note: The attachment parts are always mounted in black.

### Drive wheel: aluminum rim, hub and spokes

- Black A9000100171-003

### Caster fork and bearing block

- Black A9000100173-003

## Colour design of attachment parts according to customer request:

### Drive wheel: Aluminium rim and design inlet<sup>1</sup>

- Frame colour A9000100171-999 € 242.30  
 Select from one-colour design (different from the frame color) A9000100171-998 € 280.50  
Colour: \_\_\_\_\_  
A9000100170-

### Caster wheel: 5" aluminium rim<sup>2</sup> (3-spoke design)

- Frame colour A9000100174-999 € 73.00  
 Select from one-colour design (different from the frame color) A9000100174-998 € 84.60  
Colour: \_\_\_\_\_  
A9000100170-

## Special colour requests (frame or attachment parts)

### Frame colour for single purchasing Selection from RAL colour palette

- A9000100170-100 € 402.30

### Gloss level

- gloss  
 matt

### colour name

\_\_\_\_\_

### RAL number

\_\_\_\_\_

**Note:** attachment parts are **not** possible in design colors

<sup>1</sup> Only in conjunction with Liteline hub (with drive wheel aluminum rim with 18 or 36 spokes, single rim)

<sup>2</sup> Only in conjunction with caster wheel 5" aluminum rim 3-spoke design good shock absorption A900050121\*, as well as with suspension fork 5-spoke design A9000500160\*

## Frames

### Straight front end

A9060100010-K\*  
Knee angle 105°

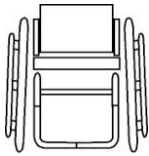

### Front end V-shape

A9060100020-K\*  
Knee angle 105°  
Note: Footrest area with V-shape  
 $x = SB - (0.25 \times USL + 6 \text{ cm})$

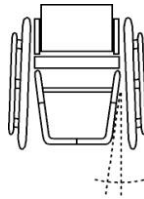

## Individual production

On request and after checking

### Seat width and seat depth

A9060100100-K € 1,213.10

Seat width 30 – 34 cm  
and/or

Seat depth 25 - 34 cm

If necessary, with forward displacement of the backrest

### Seat width 47 - 50 cm

A9060100200-K € 1,194.30

### Lower leg length 20 - 29 cm

A9060100300-K € 230.70

only for continuous footrest

## Push handles

### Back tube with integrated handles

A9000401051-K € 126.60  
straight



### Aluminum push handles fixed in back tube

A9000401050 € 126.60  
from RH 23 cm



### Horizontal push handles screwed into the back tube

A9000401076 € 234.80  
can be unscrewed



### Safety push handles height adjustable

A9000401060\* € 210.10

Mount in the back tube  
from RH 30 cm with adaptable back  
from RH 35 cm for back tube with lordosis  
support  
from RH 43 cm with back shell



### Safety push handles back-positioned length 45 cm

A9000401075 € 362.00

continuous height adjustment,  
Safety push handle holder mounted on the  
back cross bar  
Up to SB 42 cm or body weight 95 kg



### Equipment without push handles

A9000401000



## Backrest

### Folding backrest

A9060400011  
7-way angle adjustable,  
with integrated plastic-coated aluminum side  
parts



### Back tube with lordosis support

A9000400005-K € 111.10

1 cm

2 cm

3 cm



## Back equipment

If not specified, the "Adaptable back with back padding" will be delivered.

### Adaptable back with back padding

- A9000802010-K  
Cover: Black, breathable, open surface  
Equipment with back cross bar



### Back rise + 3 - 5 cm

- A9000802100 € 151.60  
for the nominal back height dimension  
Only in combination with height-adjustable  
push handles



### Equipment without back upholstery and back padding or back system

- A9000802011 € - 53.00  
Equipment with back cross bar

For other back systems for example ergonomic back shell, see separate order sheet: "PRO ACTIV seat and back systems"



## Seat upholstery

If not specified, the "Body Contour seat upholstery" will be delivered.

### Body Contour

- A9000801025-K

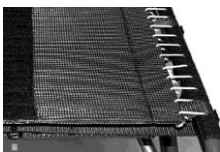

### Open belt system

- A9000801010-K € 74.70

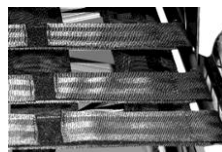

### Equipment without seat upholstery

- A9000801050



## Seat cushion

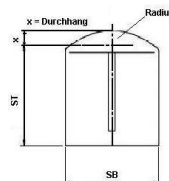
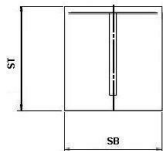

### Seat cushion in rectangular contour Inlet: Standard

- A9000805180-K\* € 111.90

### Seat cushion with radius contour Inlet: Standard

- A9000800300-K\* € 155.40

### Seat cushion height:

- 3 cm       5 cm  
 4 cm       6 cm

### Seat cushion in rectangular contour Inlet: Anti-Decubitus

- up to 30x30 cm  
A9000805204-K\* € 290.00
- >30x30 up to 50x50 cm  
A9000805200-K\* € 422.00

### Seat cushion with radius contour Inlet: Anti-Decubitus

- up to 30x30 cm  
A9000800311-K\* € 342.80
- >30x30 up to 50x50 cm  
A9000800310-K\* € 465.90

### Seat cushion height:

- 4 cm  
 6 cm

### Cover:

- Black, breathable, open surface  
 Black, breathable, closed surface

If no specification is made, the cover material "Black, breathable, open surface" will be delivered.

- Seat cushion is existing

You can also find the seat cushions on our separate order sheet: "PRO ACTIV seat and backrest systems"

## Lift mechanism

### Mechanical seat height adjustment by 30 cm

A9060300100-K\*  
via gas springs up to max. 2x1200 N  
up to approx. 100 kg

### Mechanical seat height adjustment by 30 cm

A9060300200-K\* € 956.30  
via gas springs up to max. 4x900 N  
from approx. 100 kg  
incl. lever extension

## Armrests

### Armrest with aluminum handle bar

A9060400100-K\*

### Armrest with arm padding 25 cm long

A9060400200-K\* € 161.00

### Armrest with arm padding 38 cm long

A9060400300-K\* € 191.30

## Release

### Lifting function release mechanism

attached to the armrest  
A9060403040  
 right  
 left

Note: The release mechanism is only possible on the right **OR** on the left.  
If not specified, the "release right" will be delivered.

### Lever extension for release mechanism with pivoting handle bar

A9060403440-K € 170.10

### Release mechanism, additionally equipped with a pressure plate

A9060403450 € 309.90

for force support of the finger function  
not in combination with arm padding

## Axle plate

Standard equipment with 12 mm sockets/axles

### Drive wheel plate

A9060201100  
Rear seat height approx. 45 cm  
(for 24" wheel)

### Axle plate lowered

A9060201120-K € 253.30  
Rear seat height approx. 42 cm  
(for 24" wheel)

### Extended drive wheel plate

A9060201110-K € 283.50  
Wheelbase extension by 7.5 cm

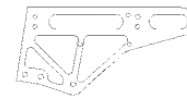

## Wheel camber

\*Total width with tight-mounted handrim.

### 1° drive wheel camber

A9060202000  
Total width = approx. ca. SB + 20 cm\*

## E-Adaptations

### Preparation for the "e-motion" mounting

A9060201200-K € 488.30

Equipment: Torque support e-motion,  
1/2" axle and socket length 50.8 mm (2")

### Preparation for the "e-fix" mounting

E35/E36  
(current model) € 488.30  
A9060201230-K

E25/E26  
(Predecessor models  
for reuse) € 488.30  
A9060201220-K

Equipment: 1/2" axle,  
socket length 50.8 mm (2") and e-fix torque  
support.  
We recommend having the e-fix installation  
carried out by Alber, as an additional safety  
circuit is required in accordance with the Alber  
installation guidelines.

## Brake system

If not specified, the "Knee lever brake system mounted at the rear" will be delivered.

### Knee lever brake system

A9060701010  
mounted at the rear



### Knee lever brake system mounted low down

A9060701015 € 151.60

Brake holding rail mounted on the axle plate, straight brake lever version



### Dual knee lever brake system

A9060701020 € 362.30

One brake mounted at the rear and another brake mounted at the front on the wheel plate with long brake lever in straight design

## Footrest

If not specified, the "continuous footrest" will be delivered.

### Continuous footrest

A9016601010-K\*  
with tubular resting bracket height adjustable +/- 3 cm  
If the footrest is wanted with a "rubber coated footplate", please select this under "Footrest accessories"



### Footbar folds up to the rear with spring locking mechanism

A9016602005-K\* € 279.00

with tubular resting bracket from USL 40 cm  
only with V-shape and frame size 3  
If the footrest is wanted with a "rubber coated footplate", please select this under "Footrest accessories"



### Footrest folds up to the rear

A9016602010-K\* € 298.90

with tubular resting bracket from USL 40 cm  
only with V-shape and long frame  
If the footrest is wanted with a "rubber coated footplate", please select this under "Footrest accessories"



### Divided footrest

A9016603200-K € 327.00

with rubber coated footplate, height adjustable +/- 3 cm, angle adjustment, can be pivoted outwards and folded up to the side  
including frame reinforcement V-shape from SB 40 cm



### „Swing Away“ footrest

A9016604100-K € 392.90

with rubber coated footplate, separated in the middle, can be folded to the side, removable, can be folded up, height-adjustable, angle-adjustable  
including frame reinforcement from USL 34 cm



### Removable front frame, foldable with divided footrest

A9065630000-K € 821.10

height adjustable, with rubber plate with straight front end, only from 100 kg user weight, only on request and after testing



## Footrest accessories

### Rubber coated footplate

A9000610000-K € 122.20

bolted, angle-adjustable  
Depth: 14 cm



### Footrest side stop

A9000610100 € 58.00

adjustable  
only in combination with rubber coated footplate



## Adaptations

### Anti-tipping support, removable

A9060300100  
removable using Quick-pin





### 3" caster wheel

#### 3" safety light-up wheel (80 mm)

A9000501110 € 68.70  
puncture-proof



### 4" caster wheel

#### 4" caster wheel „Standard“ solid rubber black

A9000501011-004  
(82A), puncture-proof



#### 4" Skate wheel (100 mm)

A9000501120 € 68.70  
puncture-proof



#### 4" safety light-up wheel (100 mm)

A9000501220 € 92.00  
puncture-proof



#### 4" Frog Legs caster wheel (100 mm)

A9000501230 € 206.30  
with replaceable rubber 6 mm, puncture-proof  
Colour: black, silver rim  
Incl. hair guard spacer (5.3 mm)



### 5" caster wheel

#### 5" caster wheel „Standard“ PU black

A9000501036-005  
(82A), puncture-proof



#### 5" caster wheel „Standard“ PU grey

A9000501031-005  
(82A), puncture-proof



#### 5" safety light-up wheel (125 mm)

A9000501221 € 92.00  
puncture-proof



#### 5" aluminum rim 3-spoke design “good shock absorption”

Silver  
A9000501210 € 174.60

Black  
A9000501211 € 174.60

with replaceable rubber 6 mm medium hard,  
puncture-proof  
Incl. hair guard spacer (3 mm)



#### 5" Frog Legs caster wheel (125 mm)

A9000501232 € 206.30  
with replaceable rubber 6 mm, puncture-proof  
Colour: black, silver rim  
Incl. hair guard spacer (5.3 mm)



6" castor wheels on request after checking, only with V-shape front end

## Caster fork

If not specified, the "standard caster fork with screw axle" is supplied.

### Caster fork Standard

A9000500100-K001  
with screwed axle

A9000500100-K002      € 162.50  
with quick-release axle



### Caster fork Heavy Duty for high loads

Extra weight approx. 100 - 150 gr.

A9000510111-K001      € 52.40  
with screwed axle

A9000510111-K002      € 212.50  
with quick-release axle



### Caster fork spare wheel „Standard“

A9000500300-K      € 288.10  
Caster fork Standard with quick-release axles



### Caster fork spare wheel „Heavy Duty“

A9000500301-K      € 328.10  
Caster fork Heavy Duty with quick-release axles



The spare caster fork does not have a caster wheel.  
In case a caster wheel is requested, please put a cross on a second selection in the category "Caster wheels".

## Track distance

### Caster wheel track extension

A9060500400-K      € 71.50  
13 mm per side



## Drive wheels

Information about other rim types, designs and availability can be found at: [www.proactiv-gmbh.de](http://www.proactiv-gmbh.de).  
If not specified, the "drive wheel 36 spokes aluminum rim" will be delivered.

### Drive wheel 36-spoke aluminum rim

24" (ETRTO 540)  
A9000203000-010  
with Liteline hub (left image),  
radially spoked  
up to 120 kg body weight

24" (ETRTO 540)  
A9000203000-020  
with aluminum front hub (right image),  
radially spoked  
over 120 kg body weight



### Drive wheel double rim 36-spokes

24" (ETRTO 540)  
A9000203100      € 153.20

25" (ETRTO 559)  
A9000203200      € 153.20

26" (ETRTO 590)  
A9000203300      € 153.20

with aluminum front hub,  
radially spoked  
Use with higher loads and body weight  
> 120 kg

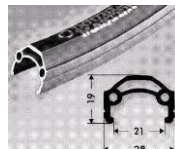

### Spinergy wheel "Spox Sport" with 24 PBO spokes; rim, hub and spokes in black

24" (ETRTO 540)  
A9000203550      € 761.30

25" (ETRTO 559)  
A9000201559      € 761.30

26" (ETRTO 590)  
A9000203555      € 761.30



# Handrims

x = dimension handrim attachment

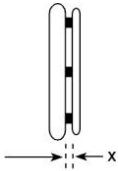

Handrim attachment  
general:

- x = 11 mm
- x = 19 mm

Handrim attachment  
Curve + Gekko handrim:

- x = 10 mm
- x = 18 mm

If not specified, the handrim will be mounted wide (19 mm / 18 mm).

## Stainless steel Ø 20 mm

- 24" handrim for 24" wheel and 25" wheel A9000205010-004
- 26" handrim for 26" wheel A9000205010-006



## Aluminum Ø 19 mm silver anodised

- 24" handrim for 24" wheel and 25" wheel A9000205019-004



## Aluminum Ø 19 mm powder coated in frame colour

(basic colour with two-colour design)

- = Gloss surface
- = Matt surface

Note: Matt coating is not recommended due to the low grip.

- 24" handrim for 24" wheel and 25" wheel A9000205020-004 € 66.30
- 26" handrim for 26" wheel A9000205020-006 € 66.30



## Aluminum Ø 19 mm polished and hard-anodised

- 24" handrim for 24" wheel and 25" wheel A9000205030-004 € 160.10
- 26" handrim for 26" wheel A9000205030-006 € 160.10



## Titanium Ø 19 mm

- 24" handrim for 24" wheel and 25" wheel A9000205040-004 € 325.80
- 26" handrim for 26" wheel A9000205040-006 € 325.80



## Silicone handrim cover

- for 24" handrim A9000205100-004 € 226.00
  - for 26" handrim A9000205100-006 € 226.00
- Surface without structure, compatible with handrim Ø 19 mm or Ø 20 mm.



## Ultra-Grip „very grippy“

- 24" handrim for 24" wheel and 25" wheel A9000205070-004 € 390.70
- 26" handrim for 26" wheel A9000205070-006 € 390.70



## Ergo-Grip

- 24" handrim for 24" wheel and 25" wheel A9000205080-004 € 396.80
  - 26" handrim for 26" wheel A9000205080-006 € 396.80
- Attachment fitting to the rim



## Curve black anodised, ergonomic handrim profile

- 24" handrim for 24" wheel and 25" wheel H 24 mm A9000205130-004 € 389.10
- 24" handrim for 24" wheel and 25" wheel H 31 mm, size L A9000205140-004 € 389.10
- 26" handrim for 26" wheel H 31 mm, size L A9000205140-006 € 389.10



<p><b>Curve silver anodised ergonomic handrim profile</b></p> <p><input type="checkbox"/> 24" handrim for 24" wheel and 25" wheel H 31 mm, size L <b>€ 394.30</b> A9000205160-004</p> 	<p><b>Curve powder-coated, ergonomic handrim profile</b></p> <p><input type="checkbox"/> = Frame colour (gloss surface) <input type="checkbox"/> = Black (gloss surface)</p> <p><input type="checkbox"/> 24" handrim for 24" wheel and 25" wheel H 24 mm <b>€ 454.00</b> A9000205135-004</p> <p><input type="checkbox"/> 24" handrim for 24" wheel and 25" wheel H 31 mm, size L <b>€ 454.00</b> A9000205145-004</p> <p><input type="checkbox"/> 26" handrim for 26" wheel H 31 mm, size L <b>€ 454.00</b> A9000205145-006</p> 	<p><b>Curve Grip, with Tetra-Grip coating, ergonomic handrim profile</b></p> <p><input type="checkbox"/> 24" handrim for 24" wheel and 25" wheel H 31 mm, size L <b>€ 505.50</b> A9000205150-004</p> 
<p><b>Quadro with Tetra-Grip coating</b></p> <p><input type="checkbox"/> 24" handrim for 24" wheel and 25" wheel <b>€ 517.50</b> A9000205170-004</p> <p><input type="checkbox"/> 25" handrim for 25" wheel <b>€ 517.50</b> A9000205170-005</p> <p><input type="checkbox"/> 26" handrim for 26" wheel <b>€ 517.50</b> A9000205170-006</p> 	<p><b>Gekko black anodised</b></p> <p><input type="checkbox"/> 24" handrim for 24" wheel and 25" wheel <b>€ 501.20</b> A9000205175-004</p> <p><input type="checkbox"/> 25" handrim for 25" wheel <b>€ 501.20</b> A9000205175-005</p> <p><input type="checkbox"/> 26" handrim for 26" wheel <b>€ 501.20</b> A9000205175-006 with a robust and replaceable silicone lip, fully integrated into the profile</p> 	<p><b>Gekko silver anodised</b></p> <p><input type="checkbox"/> 24" handrim for 24" wheel and 25" wheel <b>€ 513.20</b> A9000205185-004 with a robust and replaceable silicone lip, fully integrated into the profile</p> 
<p><b>Gekko S black anodised</b></p> <p><input type="checkbox"/> 24" handrim for 24" wheel and 25" wheel <b>€ 501.20</b> A9000205195-004 with a robust and replaceable silicone lip, fully integrated into the profile Profile height 24 mm</p> 	<p><b>Equipment without handrims</b></p> <p><input checked="" type="checkbox"/> A9000205990</p>	

## Spoke guard

### Finger- and spoke guard "transparent"

for 24" wheel  
A9000206300-004 € 201.10

for 26" wheel  
A9000206300-006 € 201.10

Not in combination with Spinergy drive wheels.



## Tyres

If not specified, the "Schwalbe RightRun in black" tyres will be delivered.

### Schwalbe „RightRun“ High-pressure tyre

24x1" (540-25)  
A9000204001-004

Colour: Black  
7.5 bar



### Schwalbe „RightRun“ High-pressure tyre

24x1" (540-25)  
A9000204000-004

25x1" (559-25)  
A9000204000-005

26x1" (590-25)  
A9000204000-006

Colour: Grey, black wall  
7.5 bar



### Schwalbe „DownTown“ Profiled tyres

24x1" (540-25)  
A9000204010-004

7.5 bar



### Schwalbe „Marathon Plus Evolution“ with "smart guard" puncture protection

24x1" (540-25)  
A9000204030-014 € 47.80

25x1" (559-25)  
A9000204030-015 € 47.80

26x1" (590-25)  
A9000204030-016 € 47.80

Colour: Black  
10 bar



### Schwalbe „Marathon Plus“ with "smart guard" puncture protection

24x1" (540-25)  
A9000204030-004 € 47.80

Colour: Grey, black wall  
10 bar



### Schwalbe „One“

24x1" (540-25)  
A9000204123-004 € 90.30

Colour: Black  
9 bar



### Puncture-proof "solid rubber tyres"

24x1" (540-25)  
A9000204201-004 € 119.10

Colour: Black

Not in combination with Spinergy drive wheels.



## Accessories

### Through axle with assistance, Large push button

A9000200096 € 102.70

Interlock dimension: 122 / 110 mm  
Axle diameter: 12 mm  
Not in conjunction with lockable drive wheel  
axle clip "Tetra Clip",  
Not in combination with one-hand drive



### Lockable drive wheel axle clip "Tetra Clip"

A9000206400 € 161.60

Not in combination with Spinergy drive wheels,  
one-hand drive, drum brake or Liteline hub

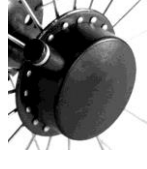

### Hand air compressor with pressure gauge

A9000901100 € 103.20

up to 14 bar



### Length-adjustable safety belt with buckle

A9000902100 € 78.30



### Adjustable safety belt with hook and fastener

A9000902110 € 62.60



### Crutch holder with flexible nylon cup

A9000902310\* € 133.40



### SIGMA lighting set

A9000903270 € 104.80

Consisting of front light and rear lights,  
chargeable via Micro USB socket,  
incl. Micro USB charging cable.  
Lighting set compliant with road traffic  
regulations



### Transport bag for drive wheels

for 24" wheel  
A9000903530-004 € 75.50  
Ø 76 cm x 2 cm

for 26" wheel  
A9000903530-006 € 75.50  
Ø 83 cm x 2 cm



Further accessories see separate order form or [www.proactiv-gmbh.de](http://www.proactiv-gmbh.de).

Notes and remarks:

### Location, Date

### Signature End customer/dealer

The signature field is intended for the consultant and insured person. This confirms that the intended equipment is intended for the insured person.

- 14 - 2024-06-01 / The prices are plus statutory value-added tax and shipping costs  = Included in the basic price  = Position selected  
Order sheet LIFT solid - mechanical Rev. 07 UK